

J.JOSÉ VERGÉS S.A.
1928

C. Joan XXIII, 20-26
08950 ESPLUGUES DE LLOBREGAT
(Barcelona, Spain)
Tel. Nacional 933 713 954*
Fax Nacional 933 725 302
Tel. Internat. 34-933 713 958*
Fax Internat. 34-933 725 302
E-Mail: estamp@verges.com



HERRAJES PARA MUEBLES GARNITURES POUR MEUBLES

FURNITURE FITTINGS MÖBELBESCHLÄGE

HERRAJES PARA MUEBLES

GARNITURES POUR MEUBLES

FURNITURE FITTINGS MÖBELBESCHLÄGE

HERRAJES PARA MUEBLES

GARNITURES POUR MEUBLES

FURNITURE FITTINGS MÖBELBESCHLÄGE





ARTTECH
COLLECTION



4 - 7	Presentación Présentation Presentation Beschreibung
8 - 67	Metal Metal Metal Metall
68 - 77	Acero Inoxidable Acier Inox Stainless Steel Rostfreier Stahl
78 - 87	Resinas y lacados Résines et laqués Resins and lacquered Harz und Lack
88 - 93	Madera Bois Wood Holz
94 - 101	Porcelana Porcelaine Porcelain Porzellan
102 - 107	Cristal Cristal Crystal Kristall
108 - 127	Complementos Complements Complements Ergänzungen
128 - 141	DecorClass
142 - 143	Índice de referencias Index de références Index of references Index der Referenzen



Descubra las últimas novedades
Découvrez les dernières nouvelles
Discover the latest news
Entdecken Sie die neuesten Nachrichten

Síguenos en...
Suivez nous sur...
Follow us on...
Finde uns auf...





Calidad certificada
Qualité certifiée
Certified quality
Zertifizierte Qualität



90 años en constante evolución

Mucho tiempo en lo que todo ha cambiado. También en **J. José Vergés**, salvo su espíritu de superación, crecimiento y expansión. Una búsqueda continua de la excelencia en la creación de herrajes, pequeñas obras de arte para sus muebles.

90 ans en constante évolution

Pendant ce temps beaucoup de choses ont changées. Chez **J. José Vergés** aussi sauf son esprit d'amélioration, croissance et développement. Une recherche continue de l'excellence dans la création de garnitures, petites oeuvres d'art pour vos meubles.

90 years in constant evolution

A long time during which everything has changed. Also at **J. José Vergés**, excepting for its eagerness to do better, to grow and to expand. A continuous search of the excellence in the creation of fittings, small masterpieces for your furniture.

90 Jahre konstanter Evolution

Eine lange Zeit, in der sich viel verändert hat. In **J. José Vergés** erhielten wir über diesen Zeitraum den Geist der Überwindung, des Wachstums und der Expansion aufrecht. Eine andauernde Suche nach vorzüglicher Kreation von Beschlägen, kleinen Kunstwerken für Ihre Möbel.



Una empresa, **J. José Vergés**, y una marca, **Estamp**, liderando desde 1928 y en 80 países en innovación, calidad y servicio para convertir sus pomos y tiradores en un referente obligado del diseño más actual.

Une entreprise, **J. José Vergés**, et une marque **Estamp**, qui est en tête depuis 1928 et dans 80 pays en innovation, qualité et service pour transformer ses boutons et poignées en une référence obligée du design le plus actuel.

A company, **J. José Vergés**, and a brand, **Estamp**, leading since 1928 and in 80 countries in innovation, quality and service turning their knobs and handles into an obliged reference of the most up to date design.

Unser Unternehmen, **J. José Vergés**, und der Markenname **Estamp**, sind führend seit 1928 in 80 Ländern auf den Gebieten Innovation, Qualität und Kundendienst. Unsere Griffe und Knöpfe sind ein obligater Bezugspunkt des modernen Designs.



● Al servicio de las últimas tendencias en decoración.

Au service des dernières tendances en décoration.

● **J. José Vergés**, en cualquier lugar del mundo y siempre cerca de sus clientes.

J. José Vergés, dans tout le monde et toujours près de ses clients.

At the service of the latest trends in decoration.

Im Dienste der aktuellsten Dekorationstrends.

J. José Vergés, throughout the world and always near their customers.

J. José Vergés, weltweit in der Nähe seiner Kunden.



PRESENTACIÓN / PRÉSENTATION
PRÉSENTATION / BESCHREIBUNG



Expertos en fabricar con la mejor calidad y el máximo respeto al medioambiente

Experts dans la fabrication avec la plus haute qualité et maximum de respect pour l'environnement

Experts in manufacturing with the highest quality and maximum respect for the environment.

Experten bei der Herstellung in hochwertiger Qualität und maximalem Respekt für die Umwelt



Formas puras, elegantes colores e impecables acabados, se unen en una sinergia perfecta para dar vida a un universo de más de 1.500 artículos que componen nuestra gama.

Formes pures, couleurs élégantes et finitions impeccables, se joignent en une synergie parfaite pour donner vie à un univers de plus de 1.500 références qui composent notre gamme.

Pure forms, elegant colours and impeccable finishes, united in a perfect synergy, to bring alive a universe with more than 1500 items in our complete range.

Reine Formen, elegante Farben und einwandfreies Finish münden in einer vollendeten Synergie, um dem Universum von weit mehr als 1500 Artikeln, die unsere Angebotspalette zusammensetzen, ein eigenes Leben zu geben.



Tecnología con alma

En **J. José Vergés** utilizamos la más alta tecnología para crear piezas de acabado perfecto y calidad garantizada, pero su esencia, lo que deben transmitir y hacer-nos sentir, lo dejamos en manos de la experiencia, el ingenio y la imaginación de nuestros diseñadores.

Une Technologie avec une âme

Chez J. José Vergés nous utilisons la plus haute technologie pour créer des pièces de finitions parfaites et une qualité garantie, mais son essence, celle qui doit nous être transmise et que l'on doit ressentir, on la laisse aux mains de l'expérience, de l'esprit et de l'imagination de nos designers.

Technology with soul

At **J. José Vergés** we use the highest technology to create pieces with a perfect finish and guaranteed quality, but the essence, what they must convey and make us feel, we leave it in the hands of experience, to the wit and imagination of our designers.

Technologie mit Herz

In J. José Vergés verwenden wir die fortgeschrittenste Technologie, um ein perfektes Finish und garantierte Qualität herzustellen. Das Wesentliche, was wir vermitteln wollen, verlassen wir gleichwohl der Erfahrung, Vorstellungskraft und Erfindungsgabe unserer Designer.



Herrajes para el mundo
Garnitures pour le monde
Fittings for the world
Beschläge für die Welt



PRESENTACIÓN / PRÉSENTATION
PRESENTATION / BESCHREIBUNG

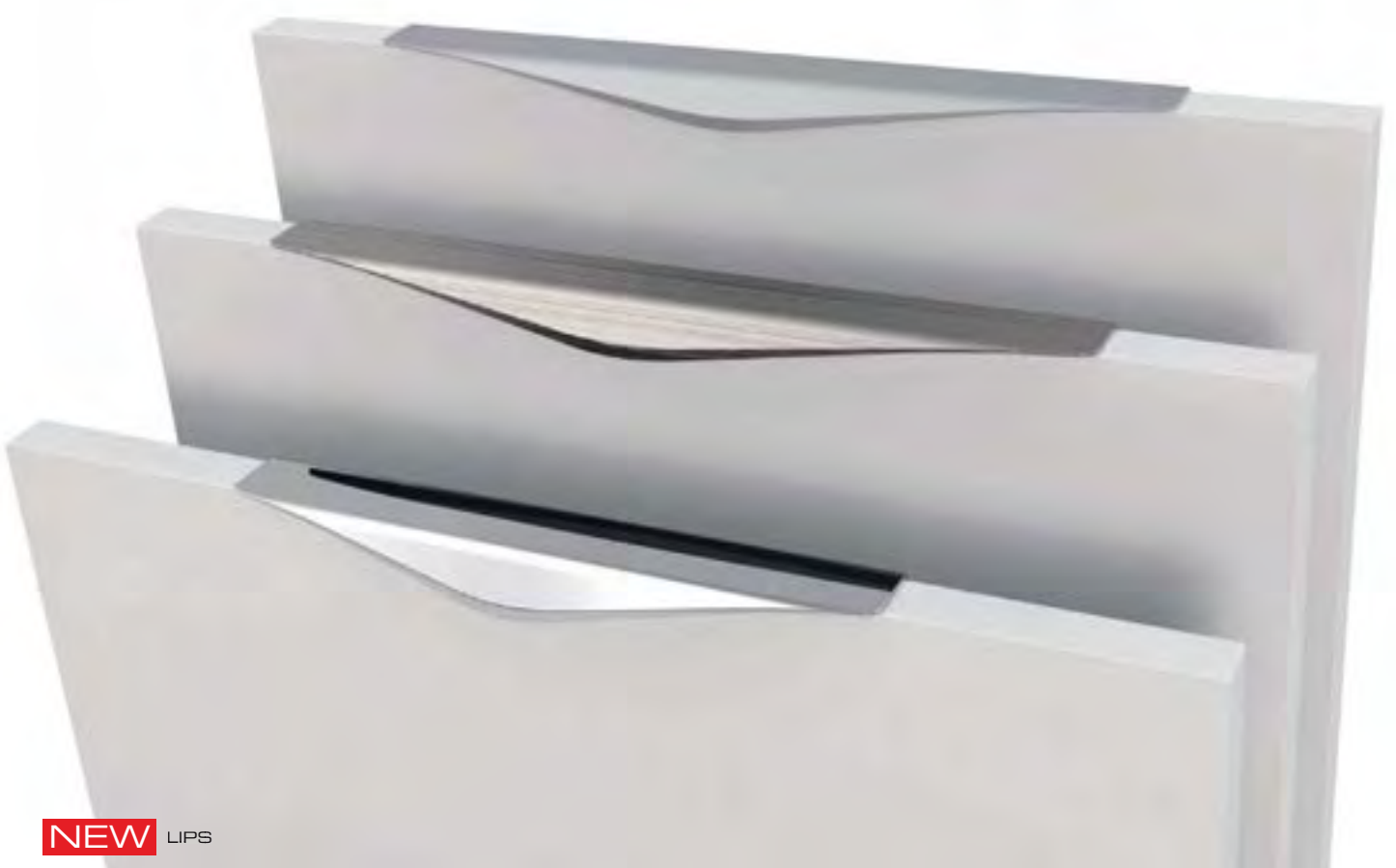
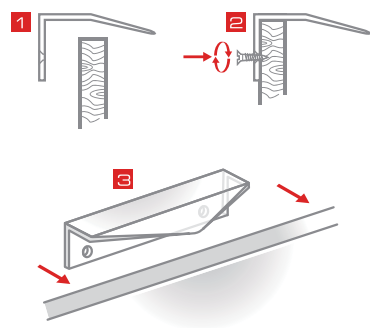

NEW LIPS

ARCH NEW

	▶mm◀	φmmφ	▶mm◀	Ømm	mm
6781	320	224	45		
6782	240	160	45		

* Grosor máximo frontal cajón: 24.5 mm
Grosueur maximale frontal tiroir: 24.5 mm
Maximum width drawer front: 24.5 mm
Dicke maximal front schublade: 24.5 mm

Inox look	038	400	800
	Níquel cepillado Nickelé brossé Brushed nickel Gebürstetes Nickel	Cromo brillo Chromé brillant Bright chrome Glänzend verchromt	Cromo mate Chromé mat Dull chrome Matt verchromt

	▶mm◀	φmmφ	φmmφ	Ømm	▶mm◀
6791	320	192		20	
6792	240	128		20	

Inox look	038	800
	Níquel cepillado Nickelé brossé Brushed nickel Gebürstetes Nickel	Cromo mate Chromé mat Dull chrome Matt verchromt



METAL / METAL / METAL / METAL

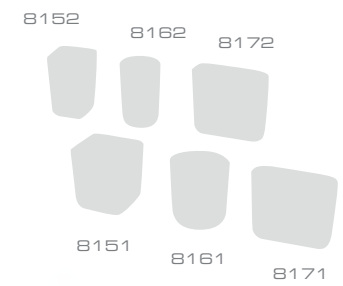

NEW ANGLE

MINI



	▶mm◀	φmmφ	▶mm	Ømm	mm
6770	245	224	37		21
6771	213	192	37		21
6772	213	192	37		21

- 
 021
 Aluminio
 Aluminium
 Aluminium
- 
Inox look
 038
 Níquel cepillado
 Nickelé brossé
 Brushed nickel
 Gebürstetes Nickel
- 
 400
 Cromo brillo
 Chromé brillant
 Bright chrome
 Glänzend verchromt
- 
 800
 Cromo mate
 Chromé mat
 Dull chrome
 Matt verchromt

	▶mm◀	▶mm◀	φmm	Ømm	mm
8151			25x25		28
8152			15x15		24
8161				25	28
8162				15	24
8171	34	14			28
8172	27	11			24

- 
 021
 Aluminio
 Aluminium
 Aluminium
- 
Inox look
 038
 Níquel cepillado
 Nickelé brossé
 Brushed nickel
 Gebürstetes Nickel
- 
 400
 Cromo brillo
 Chromé brillant
 Bright chrome
 Glänzend verchromt
- 
 800
 Cromo mate
 Chromé mat
 Dull chrome
 Matt verchromt



METAL / METAL / METAL / METAL



LUNGO

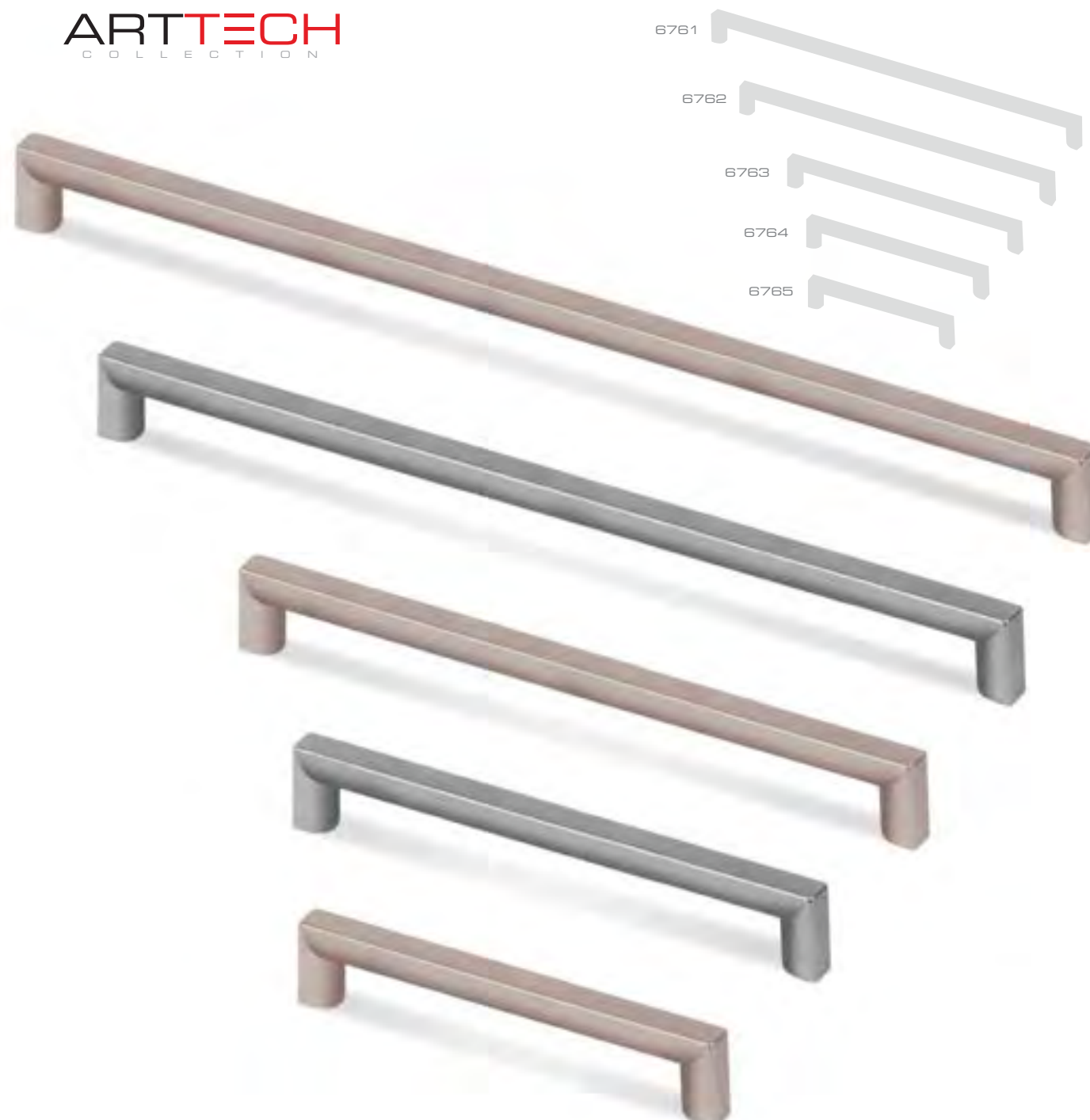

BASIC



	▶mm◀	φmmφ	▶◀mm	Ømm	mm
6180	41	32	7	39	
6181	457	448	7	39	
6182	393	384	7	39	
6183	297	288	7	39	
6184	233	224	7	39	
6185	201	192	7	39	
6186	169	160	7	39	
6187	137	128	7	39	

Inox look



038
Níquel cepillado
Nickelé brossé
Brushed nickel
Gebürstetes Nickel



400
Cromo brillo
Chromé brillant
Bright chrome
Glänzend verchromt

	▶mm◀	φmmφ	▶◀mm	mm
6761	328	320	8	28
6762	264	256	8	28
6763	200	192	8	28
6764	168	160	8	28
6765	136	128	8	28

Inox look



038
Níquel cepillado
Nickelé brossé
Brushed nickel
Gebürstetes Nickel



800
Cromo mate
Chromé mat
Dull chrome
Matt verchromt



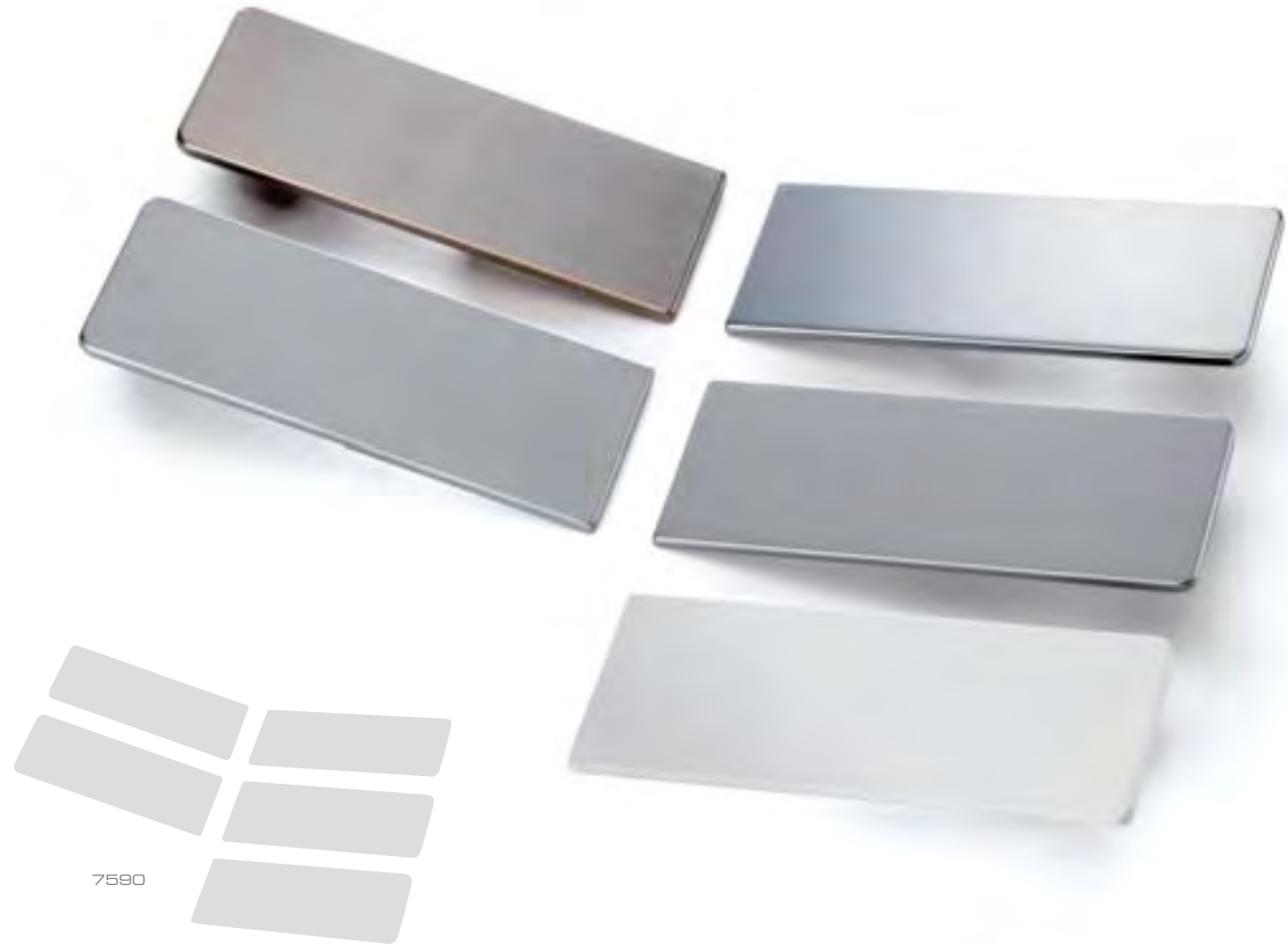

7590



6751
6752
7751

WING

JAZZ



	▶mm◀	φmmφ	mm	mm
7590	98	16	23	39

ZAMAK
METAL
METAL
METALL

- 
021
 Aluminio
 Aluminium
 Aluminium
 Aluminium
- 
038
 Niquel cepillado
 Nickelé brossé
 Brushed nickel
 Gebürstetes Nickel
- 
292
 Blanco mate
 Blanc mat
 Dull white
 Matt Weiß
- 
400
 Cromo brillo
 Chromé brillant
 Bright chrome
 Glänzend verchromt
- 
800
 Cromo mate
 Chromé mat
 Dull chrome
 Matt verchromt

	▶mm◀	φmmφ	mm	mm	mm
7751	204	160	25	29	
6751	332	288	25	29	
6752	268	224	25	29	

ZAMAK
METAL
METAL
METALL

- 
021
 Aluminio
 Aluminium
 Aluminium
 Aluminium
- 
038
 Niquel cepillado
 Nickelé brossé
 Brushed nickel
 Gebürstetes Nickel
- 
400
 Cromo brillo
 Chromé brillant
 Bright chrome
 Glänzend verchromt
- 
800
 Cromo mate
 Chromé mat
 Dull chrome
 Matt verchromt

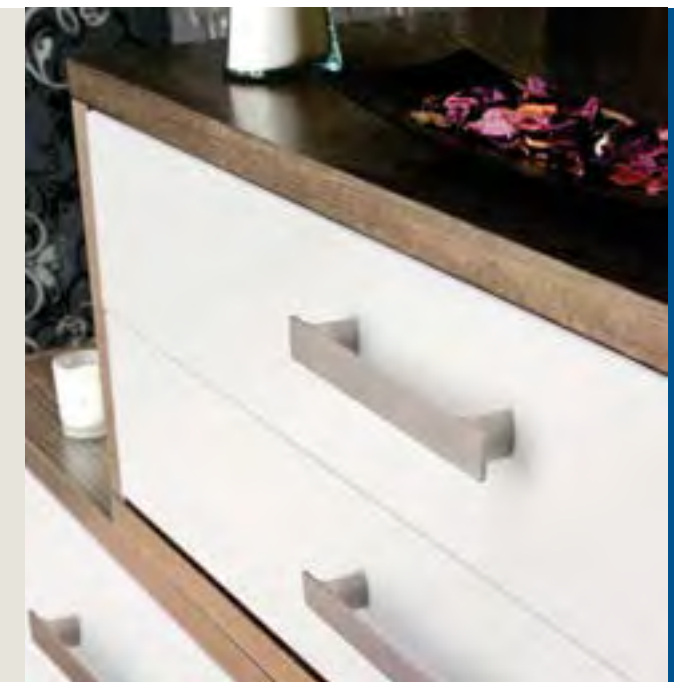



EDGE



I-SPAZIO



	mm	mm	mm	mm	mm
7531	188	160	9	35	
7532	124	96	8	30	

021 Aluminio Aluminium Aluminium	Inox look 038 Níquel cepillado Nickelé brossé Brushed nickel Gebürstetes Nickel	400 Cromo brillo Chromé brillant Bright chrome Glänzend verchromt	800 Cromo mate Chromé mat Dull chrome Matt verchromt
---	--	---	--



	mm	mm	mm	A	B	C	mm
7570	260	192	8	22	108	130	32
7571	260	192	8	76	108	76	32
7572	200	128	8	56	88	56	32

021 Aluminio Aluminium Aluminium	032 Negro mate Noir mat Dull black Mattschwarz	Inox look 038 Níquel cepillado Nickelé brossé Brushed nickel Gebürstetes Nickel
292 Blanco mate Blanc mat Dull white Matt Weiß	400 Cromo brillo Chromé brillant Bright chrome Glänzend verchromt	800 Cromo mate Chromé mat Dull chrome Matt verchromt



ARTTECH
COLLECTION

STRIPE



ARTTECH
COLLECTION

SMOOTH



	▶mm◀	⌀mm	▶mm	Ømm	✂mm
7681	238	192	25	27	
7682	195	160	24	27	
7683	153	128	23	27	
7684	120	96	22	27	

021 Aluminio Aluminium Aluminium Aluminium	038 Niquel cepillado Nickelé brossé Brushed nickel Gebürstetes Nickel	400 Cromo brillo Chromé brillant Bright chrome Glänzend verchromt	800 Cromo mate Chromé mat Dull chrome Matt verchromt

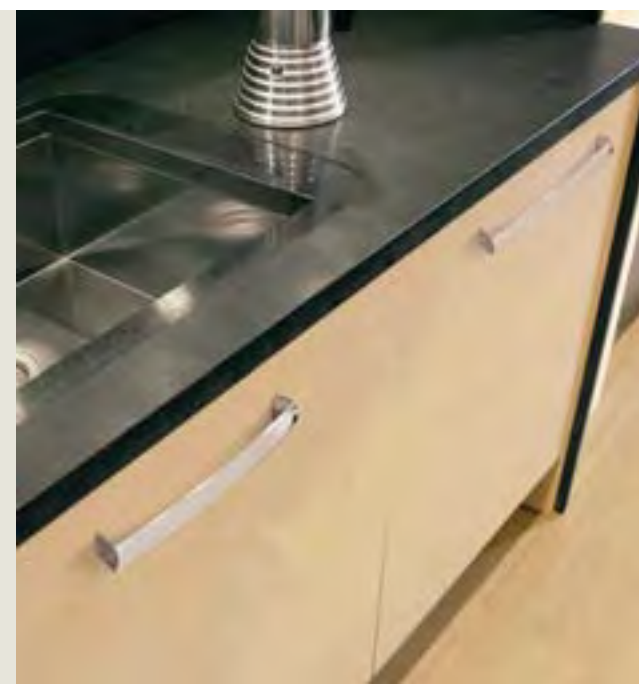

	▶mm◀	⌀mm	▶mm	Ømm	✂mm
7651	232	224	30	28	
7652	200	192	30	28	
7653	168	160	30	28	

038 Niquel cepillado Nickelé brossé Brushed nickel Gebürstetes Nickel	400 Cromo brillo Chromé brillant Bright chrome Glänzend verchromt	800 Cromo mate Chromé mat Dull chrome Matt verchromt

METAL / METAL / METAL / METAL



DUAL

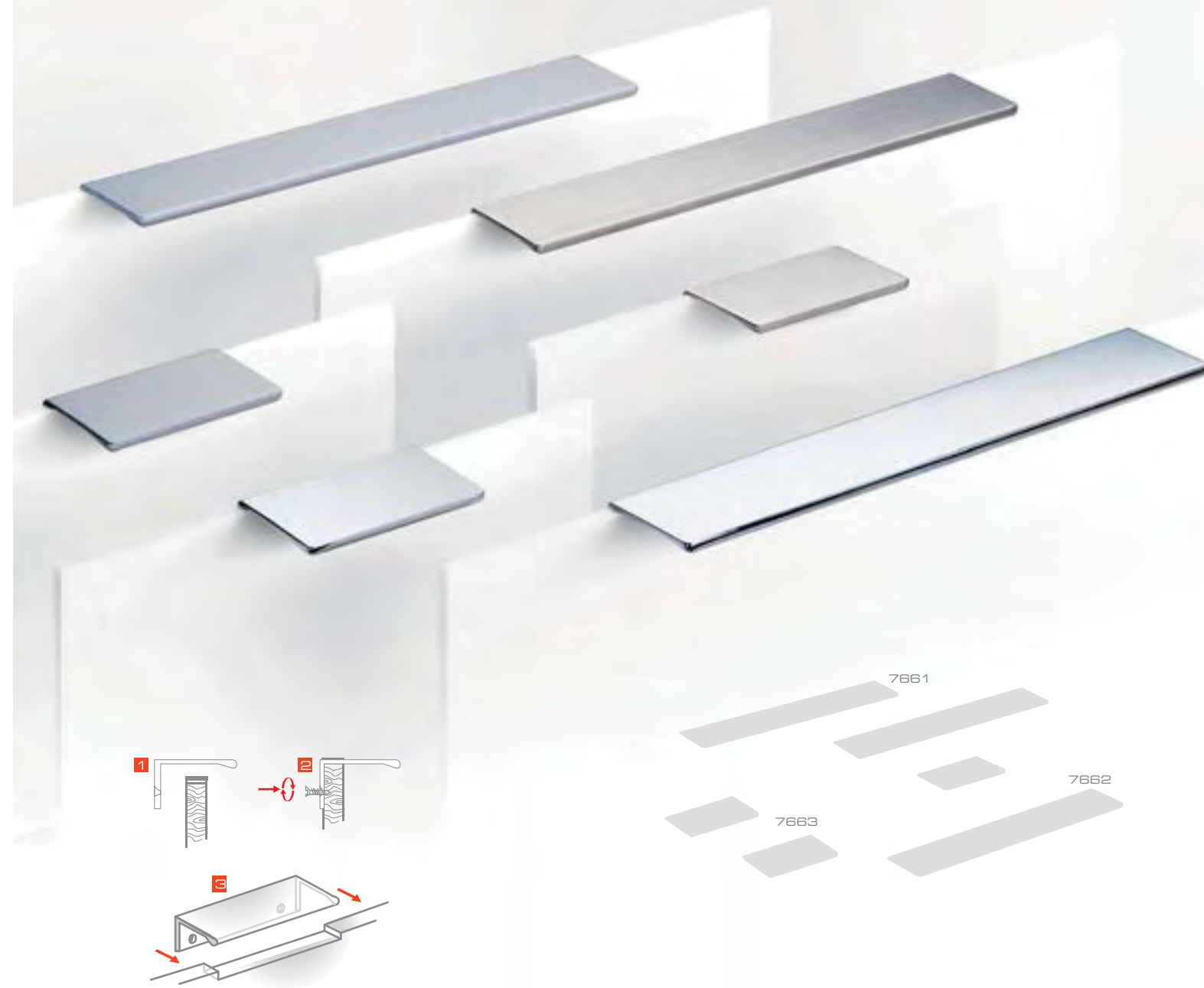

SYNTHESIS

	mm	mm	mm	mm	ZAMAK METAL METAL METALL
7691	201	192	10	26	
7692	169	160	10	26	
7693	137	128	10	26	
7694	26	16	10	26	

Inox look	038	400	800
Níquel cepillado	Cromo brillo	Cromo mate	
Nickelé brossé	Chromé brillant	Chromé mat	
Brushed nickel	Bright chrome	Dull chrome	
Gebürstetes Nickel	Glänzend verchromt	Matt verchromt	



	mm	mm	mm	mm	ZAMAK METAL METAL METALL
7661	230	192	44	24	
7662	135	96	44	24	
7663	71	32	44	24	

021	Inox look	038	400	800
Aluminio	Níquel cepillado	Cromo brillo	Cromo mate	
Aluminium	Nickelé brossé	Chromé brillant	Chromé mat	
Aluminium	Brushed nickel	Bright chrome	Dull chrome	
Aluminium	Gebürstetes Nickel	Glänzend verchromt	Matt verchromt	



7520
7521
7020
7021
7022
7023
7024
7025
7026

ALUSTYLE

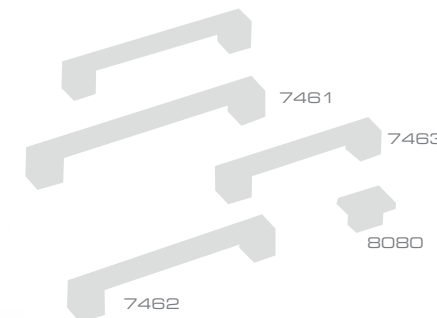

7461
7463
8080
7462

BLOCK



	▶mm◀	◊mm◊	▶mm◀	Ømm	✚mm
7020	462	448	14	35	
7021	398	384	14	35	
7022	302	288	14	35	
7023	238	224	14	35	
7024	206	192	14	35	
7025	174	160	14	35	
7026	142	128	14	35	
7520	846	832	14	35	
7521	654	640	14	35	

ALUMINIO
ALUMINIUM
ALUMINIUM
ALUMINIUM

018
Aluminio anodizado
Aluminium anodisé
Anodized aluminium
Aluminium eloxiert

	▶mm◀	◊mm◊	▶mm◀	Ømm	✚mm
7461	197	160	21		
7462	161	128	19		
7463	129	96	18		

ZAMAK
METAL
METAL
METALL

021
Aluminio
Aluminium
Aluminium

038
Inox look
Níquel cepillado
Nickelé brossé
Brushed nickel
Gebürstetes Nickel

400
Cromo brillo
Chromé brillant
Bright chrome
Glänzend verchromt

800
Cromo mate
Chromé mat
Dull chrome
Matt verchromt

	▶mm◀	◊mm◊	▶mm◀	Ømm	✚mm
8080		16			37x25

ZAMAK
METAL
METAL
METALL

038
Inox look
Níquel cepillado
Nickelé brossé
Brushed nickel
Gebürstetes Nickel

400
Cromo brillo
Chromé brillant
Bright chrome
Glänzend verchromt

800
Cromo mate
Chromé mat
Dull chrome
Matt verchromt

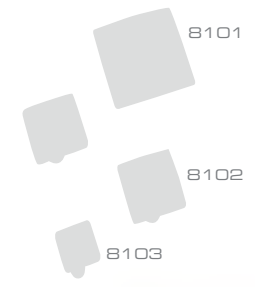

ALIGN

WAVE

	mm	mm	mm	mm	mm
7541	252	224	9		
7542	208	192	9		
7543	157	128	9		

	mm	mm	mm	mm	mm
8130				15x15	

021	038	400	800
Aluminio	Niquel cepillado	Cromo brillo	Cromo mate
Aluminium	Nickelé brossé	Chromé brillant	Chromé mat
Aluminium	Brushed nickel	Bright chrome	Dull chrome
Aluminium	Gebürstetes Nickel	Glänzend verchromt	Matt verchromt

038	400	800
Niquel cepillado	Cromo brillo	Cromo mate
Nickelé brossé	Chromé brillant	Chromé mat
Brushed nickel	Bright chrome	Dull chrome
Gebürstetes Nickel	Glänzend verchromt	Matt verchromt



	mm	mm	mm	mm	mm
8101				80x80	
8102				50x50	
8103				32x32	

021	038	400	800
Aluminio	Niquel cepillado	Cromo brillo	Cromo mate
Aluminium	Nickelé brossé	Chromé brillant	Chromé mat
Aluminium	Brushed nickel	Bright chrome	Dull chrome
Aluminium	Gebürstetes Nickel	Glänzend verchromt	Matt verchromt

ARTTECH

COLLECTION



CUBIC

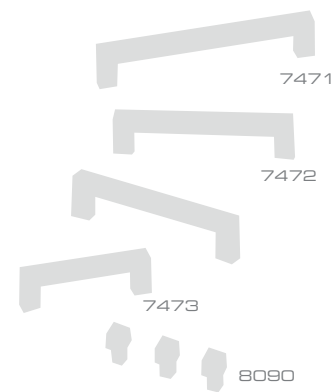

8090



SQUARE

ARTTECH

COLLECTION

	▶mm◀	φmmφ	▶◀mm	Ømm	↺mm
7481	115	96	12		
7482	85	64	11		
7483	55	32	10		

021 Aluminio Aluminium Aluminium Aluminium	Inox look 038 Níquel cepillado Nickelé brossé Brushed nickel Gebürstetes Nickel	400 Cromo brillo Chromé brillant Bright chrome Glänzend verchromt	800 Cromo mate Chromé mat Dull chrome Matt verchromt



	▶mm◀	φmmφ	▶◀mm	Ømm	↺mm
7471	146	128	12		
7472	114	96	11		
7473	81	64	10		
8090					12x12

021 Aluminio Aluminium Aluminium Aluminium	Inox look 038 Níquel cepillado Nickelé brossé Brushed nickel Gebürstetes Nickel	400 Cromo brillo Chromé brillant Bright chrome Glänzend verchromt	800 Cromo mate Chromé mat Dull chrome Matt verchromt





	▶mm◀	φmmφ	▶mm	Ømm	↺mm
7241	200	192	20		
7242	168	160	20		

ZAMAK
METAL
METAL
METALL

	▶mm◀	φmmφ	▶mm	Ømm	↺mm
7381	200	128	19		
7382	160	96	17		

ZAMAK
METAL
METAL
METALL

	▶mm◀	φmmφ	▶mm	Ømm	↺mm
8851				50x35	
8852				35x24	

ZAMAK
METAL
METAL
METALL

021 Aluminio Aluminium Aluminium	Inox look 038 Niquel cepillado Nickelé brossé Brushed nickel Gebürstetes Nickel	400 Cromo brillo Chromé brillant Bright chrome Glänzend verchromt	800 Cromo mate Chromé mat Dull chrome Matt verchromt

021 Aluminio Aluminium Aluminium	Inox look 038 Niquel cepillado Nickelé brossé Brushed nickel Gebürstetes Nickel	400 Cromo brillo Chromé brillant Bright chrome Glänzend verchromt	800 Cromo mate Chromé mat Dull chrome Matt verchromt

Inox look 038 Niquel cepillado Nickelé brossé Brushed nickel Gebürstetes Nickel	400 Cromo brillo Chromé brillant Bright chrome Glänzend verchromt	800 Cromo mate Chromé mat Dull chrome Matt verchromt

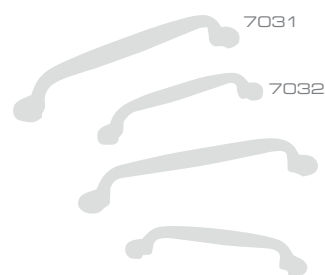

	mm	mm	mm	mm
7031	160	128	14	
7032	126	96	13	



	mm	mm	mm	mm
7251	149	128	20	
7252	117	96	18	

	mm	mm	mm	mm
8780				20x20

- 
030
 Bronce cepillado
 Bronze brossé
 Brushed bronze
 Gebürstet bronziert
- 
038
 Níquel cepillado
 Nickelé brossé
 Brushed nickel
 Gebürstetes Nickel
- 
100
 Dorado brillo
 Doré brillant
 Gold plated
 Glänzend vergoldet
- 
400
 Cromo brillo
 Chromé brillant
 Bright chrome
 Glänzend verchromt
- 
800
 Cromo mate
 Chromé mat
 Dull chrome
 Matt verchromt
- 
807
 Hierro rústico
 Fer rustique
 Rustic iron
 Eisen rustikal
- 
831
 Bronce rústico
 Bronze rustique
 Antique brass
 Bronze rustikal
- 
836
 Estaño rústico
 Etain rustique
 Rustic tin
 Zinn rustikal

- 
038
 Níquel cepillado
 Nickelé brossé
 Brushed nickel
 Gebürstetes Nickel
- 
100
 Dorado brillo
 Doré brillant
 Gold plated
 Glänzend vergoldet
- 
805
 Latón cepillado rústico
 Laiton brossé rustique
 Rustic brushed brass
 Messing rustikal, gebürstet
- 
021
 Aluminio
 Aluminium
 Aluminium
- 
038
 Níquel cepillado
 Nickelé brossé
 Brushed nickel
 Gebürstetes Nickel
- 
100
 Dorado brillo
 Doré brillant
 Gold plated
 Glänzend vergoldet
- 
831
 Bronce rústico
 Bronze rustique
 Antique brass
 Bronze rustikal
- 
836
 Estaño rústico
 Etain rustique
 Rustic tin
 Zinn rustikal
- 
805
 Latón cepillado rústico
 Laiton brossé rustique
 Rustic brushed brass
 Messing rustikal, gebürstet
- 
831
 Bronce rústico
 Bronze rustique
 Antique brass
 Bronze rustikal
- 
836
 Estaño rústico
 Etain rustique
 Rustic tin
 Zinn rustikal

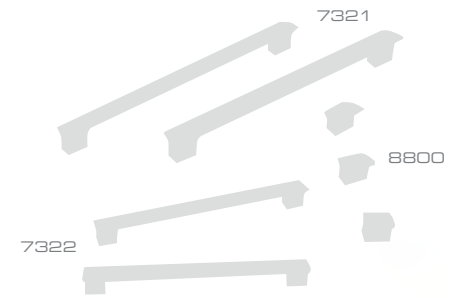

	▶mm◀	φmmφ	▶◀mm	Ømm	↺mm
7411	192	160	22		
7412	153	128	21		

ZAMAK
METAL
METAL
METALL



	▶mm◀	φmmφ	▶◀mm	Ømm	↺mm
7321	208	192	24		
7322	176	160	24		
8800				30x22	

ZAMAK
METAL
METAL
METALL

Inox look

038

Níquel cepillado
Nickeléd brossé
Brushed nickel
Gebürstetes Nickel

400

Cromo brillo
Chroméd brillant
Bright chrome
Glänzend verchromt

800

Cromo mate
Chroméd mat
Dull chrome
Matt verchromt



021

Aluminio
Aluminium
Aluminium

Inox look

038

Níquel cepillado
Nickeléd brossé
Brushed nickel
Gebürstetes Nickel

400

Cromo brillo
Chroméd brillant
Bright chrome
Glänzend verchromt

800

Cromo mate
Chroméd mat
Dull chrome
Matt verchromt

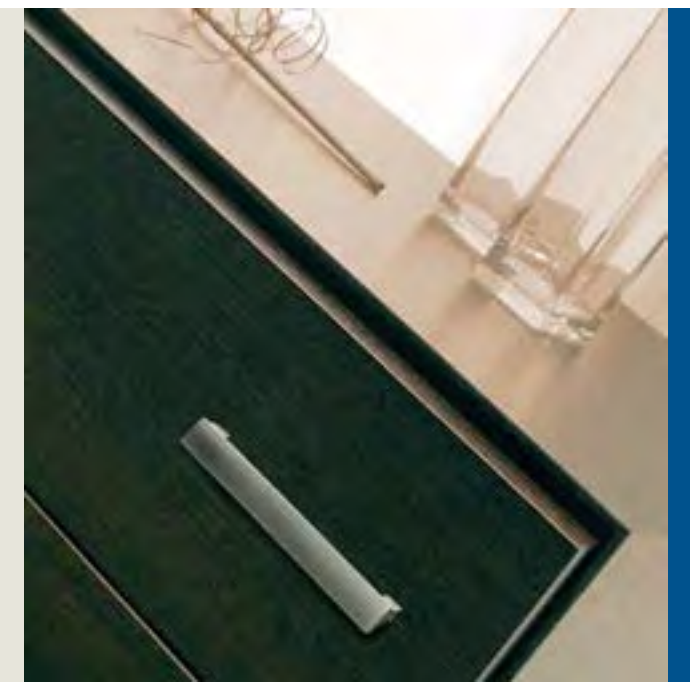

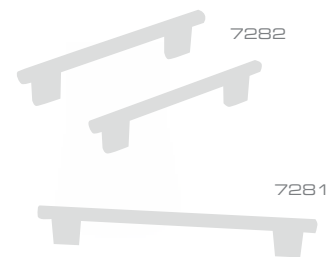
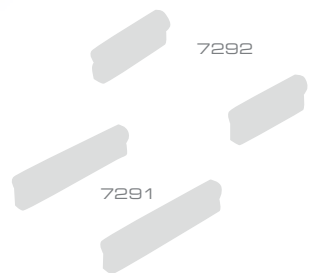

	▶mm◀	φmmφ	▶mm	Ømm	⊕mm
7291	81	64		12	
7292	48	32		12	

- 
021
 Aluminio
 Aluminium
 Aluminium
- 
038
 Níquel cepillado
 Nickelé brossé
 Brushed nickel
 Gebürstetes Nickel
- 
400
 Cromo brillo
 Chromé brillant
 Bright chrome
 Glänzend verchromt
- 
500
 Níquel satinado
 Nickelé satiné
 Satin nickel
- 
800
 Cromo mate
 Chromé mat
 Dull chrome
 Matt verchromt



	▶mm◀	φmmφ	▶mm	Ømm	⊕mm
7281	242	192		12	
7282	178	128		12	

- 
038
 Níquel cepillado
 Nickelé brossé
 Brushed nickel
 Gebürstetes Nickel
- 
400
 Cromo brillo
 Chromé brillant
 Bright chrome
 Glänzend verchromt
- 
800
 Cromo mate
 Chromé mat
 Dull chrome
 Matt verchromt



	▶mm◀	⌀mm⌀	▶mm	Ømm	↻mm
7131	165	128	20		
7132	130	96	16		
7140	53	32	19		

	▶mm◀	⌀mm⌀	▶mm	Ømm	↻mm
7150	152	96	20		

- 021**
 Aluminio
 Aluminium
 Aluminium
 Aluminium
- 032**
 Negro mate
 Noir mat
 Dull black
 Mattschwarz
- 038**
 Niquel cepillado
 Nickelé brossé
 Brushed nickel
 Gebürstetes Nickel
- 100**
 Dorado brillo
 Doré brillant
 Gold plated
 Glänzend vergoldet
- 400**
 Cromo brillo
 Chromé brillant
 Bright chrome
 Glänzend verchromt
- 500**
 Niquel satinado
 Nickelé satiné
 Satin nickel
 Satiniertes Nickel
- 800**
 Cromo mate
 Chromé mat
 Dull chrome
 Matt verchromt



- 021**
 Aluminio
 Aluminium
 Aluminium
 Aluminium
- 038**
 Niquel cepillado
 Nickelé brossé
 Brushed nickel
 Gebürstetes Nickel
- 400**
 Cromo brillo
 Chromé brillant
 Bright chrome
 Glänzend verchromt
- 500**
 Niquel satinado
 Nickelé satiné
 Satin nickel
 Satiniertes Nickel
- 800**
 Cromo mate
 Chromé mat
 Dull chrome
 Matt verchromt



	►mm◄	φmmφ	►mm◄	Ømm	~mm
8701				35	
8702				30	



	►mm◄	φmmφ	►mm◄	Ømm	~mm
8711				37x30	
8712				32x26	



	►mm◄	φmmφ	►mm◄	Ømm	~mm
7121	163	128	23		
7122	129	96	20		



	►mm◄	φmmφ	►mm◄	Ømm	~mm
8731				35	
8732				30	



002 Blanco
Blanc
White
Weiß

030 Bronce cepillado
Bronze brossé
Brushed bronze
Gebürstetes bronziert

Inox look
038 Níquel cepillado
Nickelé brossé
Brushed nickel
Gebürstetes Nickel

100 Dorado brillo
Doré brillant
Gold plated
Glänzend vergoldet



400 Cromo brillo
Chromé brillant
Bright chrome
Glänzend verchromt

800 Cromo mate
Chromé mat
Dull chrome
Matt verchromt

831 Bronce rústico
Bronze rustique
Antique brass
Bronze rustikal

836 Estaño rústico
Etain rustique
Rustic tin
Zinn rustikal



Inox look
038 Níquel cepillado
Nickelé brossé
Brushed nickel
Gebürstetes Nickel

800 Cromo mate
Chromé mat
Dull chrome
Matt verchromt



032 Negro mate
Noir mat
Dull black
Mattschwarz

Inox look
038 Níquel cepillado
Nickelé brossé
Brushed nickel
Gebürstetes Nickel



Inox look
038 Níquel cepillado
Nickelé brossé
Brushed nickel
Gebürstetes Nickel



	▶mm◀	φmmφ	▶mm▶	Ømm	↳mm
7081	142	128	15		
7082	107	96	13		

	▶mm▶	φmmφ	▶mm▶	Ømm	↳mm
7930	137	96	14		

	▶mm▶	φmmφ	▶mm▶	Ømm	↳mm
7051	148	128	16		
7052	112	96	13		

	▶mm▶	φmmφ	▶mm▶	Ømm	↳mm
8671				34x22	
8672				31x20	
8673				25x17	

Inox look

		
038	100	500
Níquel cepillado Nickelé brossé Brushed nickel Gebürstetes Nickel	Dorado brillo Doré brillant Gold plated Glänzend vergoldet	Níquel satinado Nickelé satiné Satin nickel Satiertes Nickel

Inox look

038
Níquel cepillado Nickelé brossé Brushed nickel Gebürstetes Nickel

Inox look

			
038	100	400	800
Níquel cepillado Nickelé brossé Brushed nickel Gebürstetes Nickel	Dorado brillo Doré brillant Gold plated Glänzend vergoldet	Cromo brillo Chromé brillant Bright chrome Glänzend verchromt	Cromo mate Chromé mat Dull chrome Matt verchromt

Inox look

			
038	100	400	800
Níquel cepillado Nickelé brossé Brushed nickel Gebürstetes Nickel	Dorado brillo Doré brillant Gold plated Glänzend vergoldet	Cromo brillo Chromé brillant Bright chrome Glänzend verchromt	Cromo mate Chromé mat Dull chrome Matt verchromt



	▶mm◀	φmmφ	▶mm	Ømm	↳mm
7061	130	96		11	
7062	98	64		10	





ZAMAK
METAL
METAL
METALL

- 
032
 Negro mate
 Noir mat
 Dull black
 Mattschwarz
- 
038
 Niquel cepillado
 Nickelé brossé
 Brushed nickel
 Gebürstetes Nickel
- 
100
 Dorado brillo
 Doré brillant
 Gold plated
 Glänzend vergoldet
- 
800
 Cromo mate
 Chromé mat
 Dull chrome
 Matt verchromt





	▶mm◀	φmmφ	▶mm	Ømm	↳mm
7991	111	96		7	
7992	76	64		6	

ZAMAK
METAL
METAL
METALL

- 
021
 Aluminio
 Aluminium
 Aluminium
 Aluminium
- 
038
 Niquel cepillado
 Nickelé brossé
 Brushed nickel
 Gebürstetes Nickel
- 
100
 Dorado brillo
 Doré brillant
 Gold plated
 Glänzend vergoldet
- 
400
 Cromo brillo
 Chromé brillant
 Bright chrome
 Glänzend verchromt

	▶mm◀	φmmφ	▶mm	Ømm	↳mm
8721				18	
8722				13	

LATÓN
LAITON
BRASS
MESSING

- 
021
 Aluminio
 Aluminium
 Aluminium
 Aluminium
- 
038
 Niquel cepillado
 Nickelé brossé
 Brushed nickel
 Gebürstetes Nickel
- 
100
 Dorado brillo
 Doré brillant
 Gold plated
 Glänzend vergoldet
- 
400
 Cromo brillo
 Chromé brillant
 Bright chrome
 Glänzend verchromt

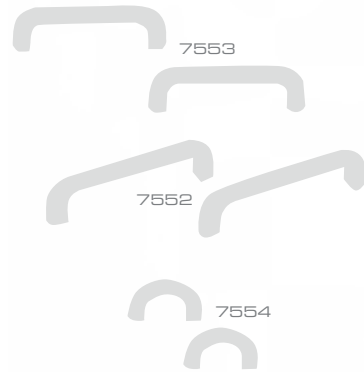

ZAMAK
METAL
METAL
METALL

	▶mm◀	φmm	▶mm	Ømm	φmm
7552	108	96	10		
7553	80	70	9		
7554	42	32	9		



ZAMAK
METAL
METAL
METALL

	▶mm◀	φmm	▶mm	Ømm	φmm
7861	164	128	10		
7862	124	96	9		







	ZAMAK METAL METAL METALL
8830	30x19

	LATÓN LAITON BRASS MESSING
8810	16
8820	16

	ZAMAK METAL METAL METALL
8351	33
8352	28
8353	24
8354	18

	ZAMAK METAL METAL METALL
8321	33
8322	28
8323	24
8324	18

- 
021
 Aluminio
 Aluminium
 Aluminium
 Aluminium
- 
038
 Niquel cepillado
 Nickelé brossé
 Brushed nickel
 Gebürstetes Nickel
- 
400
 Cromo brillo
 Chromé brillant
 Bright chrome
 Glänzend verchromt
- 
800
 Cromo mate
 Chromé mat
 Dull chrome
 Matt verchromt

- 
021
 Aluminio
 Aluminium
 Aluminium
 Aluminium
- 
038
 Niquel cepillado
 Nickelé brossé
 Brushed nickel
 Gebürstetes Nickel

- 
100
 Dorado brillo
 Doré brillant
 Gold plated
 Glänzend vergoldet
- 
400
 Cromo brillo
 Chromé brillant
 Bright chrome
 Glänzend verchromt
- 
800
 Cromo mate
 Chromé mat
 Dull chrome
 Matt verchromt
- 
900
 Bronce viejo
 Vieux bronze
 Old bronze
 Antik bronziert
- 
038
 Niquel cepillado
 Nickelé brossé
 Brushed nickel
 Gebürstetes Nickel
- 
100
 Dorado brillo
 Doré brillant
 Gold plated
 Glänzend vergoldet
- 
400
 Cromo brillo
 Chromé brillant
 Bright chrome
 Glänzend verchromt
- 
800
 Cromo mate
 Chromé mat
 Dull chrome
 Matt verchromt



ZAMAK
METAL
METAL
METALL

►mm◄ ◊mm◊ ▶|mm ◊mm ◊mm

8010 12

ZAMAK
METAL
METAL
METALL

►mm◄ ◊mm◊ ▶|mm ◊mm ◊mm

8790 20

ZAMAK
METAL
METAL
METALL

►mm◄ ◊mm◊ ▶|mm ◊mm ◊mm

7830 110 96 11

- 002
Blanco
Blanc
White
Weiß
- 021
Aluminio
Aluminium
Aluminium
Aluminium
- 033
Negro brillo
Noir brillant
Bright black
Glänzend schwarz

- 021
Aluminio
Aluminium
Aluminium
Aluminium
- Inox look**
038
Níquel cepillado
Nickelé brossé
Brushed nickel
Gebürstetes Nickel
- 400
Cromo brillo
Chromé brillant
Bright chrome
Glänzend verchromt

- 100
Dorado brillo
Doré brillant
Gold plated
Glänzend vergoldet
- 102
Blanco/Dorado brillo
Blanc/Doré brillant
White/Gold plated
Weiß/Glänzend vergoldet
- 831
Bronce rústico
Bronze rustique
Antique brass
Bronze rustikal
- 836
Estaño rústico
Etain rustique
Rustic tin
Zinn rustikal
- 900
Bronce viejo
Vieux bronze
Old bronze
Antik bronziert

- 100
Dorado brillo
Doré brillant
Gold plated
Glänzend vergoldet
- 400
Cromo brillo
Chromé brillant
Bright chrome
Glänzend verchromt

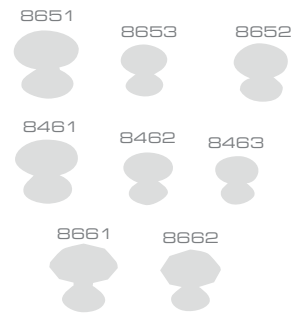

	ZAMAK METAL METAL METALL
▶mm◀	φmmφ ▶ ◀mm Ømm ↻-mm
8471	35
8472	30
8473	25

	ZAMAK METAL METAL METALL
▶mm◀	φmmφ ▶ ◀mm Ømm ↻-mm
8651	35
8652	30
8653	25

	ZAMAK METAL METAL METALL
▶mm◀	φmmφ ▶ ◀mm Ømm ↻-mm
8461	35
8462	30
8463	25

	ZAMAK METAL METAL METALL
▶mm◀	φmmφ ▶ ◀mm Ømm ↻-mm
8661	35
8662	28

- 100 Dorado brillo / Doré brillant / Gold plated / Glänzend vergoldet
- 102 Blanco/Dorado brillo / Blanc/Doré brillant / White/Gold plated / Weiß/Glänzend vergoldet
- 400 Cromo brillo / Chromé brillant / Bright chrome / Glänzend verchromt
- 900 Bronce viejo / Vieux bronze / Old bronze / Antik bronziert

- 100 Dorado brillo / Doré brillant / Gold plated / Glänzend vergoldet
- 831 Bronce rústico / Bronze rustique / Antique brass / Bronze rustikal
- 836 Estaño rústico / Etain rustique / Rustic tin / Zinn rustikal
- 900 Bronce viejo / Vieux bronze / Old bronze / Antik bronziert

- 100 Dorado brillo / Doré brillant / Gold plated / Glänzend vergoldet
- 805 Latón cepillado rústico / Laiton brossé rustique / Rustic brushed brass / Messing rustikal, gebürstet
- 900 Bronce viejo / Vieux bronze / Old bronze / Antik bronziert

- 038 Níquel cepillado / Nickelé brossé / Brushed nickel / Gebürstetes Nickel
- 100 Dorado brillo / Doré brillant / Gold plated / Glänzend vergoldet

NEWRUSTIC
COLLECTION

NEWRUSTIC
COLLECTION



	mm	mm	mm
7421	120	96	14
7422	81	64	11
8871			30



	mm	mm	mm
7371	178	128	22
7372	137	96	20
8841			34
8842			28

ZAMAK
METAL
METAL
METALL

ZAMAK
METAL
METAL
METALL

- 
805
 Latón cepillado rústico
 Laiton brossé rustique
 Rustic brushed brass
 Messing rustikal, gebürstet
- 
807
 Hierro rústico
 Fer rustique
 Rustic iron
 Eisen rustikal
- 
808
 Cobre rústico
 Cuivre rustique
 Rustic copper
 Kupfer rustikal
- 
809
 Níquel negro cepillado rústico
 Nickelé noir brossé rustique
 Black nickel rustic brushed
 Nickel schwarz rustikal, gebürstet
- 
831
 Bronce rústico
 Bronze rustique
 Antique brass
 Bronze rustikal
- 
836
 Estaño rústico
 Etain rustique
 Rustic tin
 Zinn rustikal

- 
038
 Inox look
 Níquel cepillado
 Nickelé brossé
 Brushed nickel
 Gebürstetes Nickel
- 
808
 Cobre rústico
 Cuivre rustique
 Rustic copper
 Kupfer rustikal
- 
809
 Níquel negro cepillado rústico
 Nickelé noir brossé rustique
 Black nickel rustic brushed
 Nickel schwarz rustikal, gebürstet
- 
831
 Bronce rústico
 Bronze rustique
 Antique brass
 Bronze rustikal
- 
836
 Estaño rústico
 Etain rustique
 Rustic tin
 Zinn rustikal

METAL / METAL / METAL / METALL

COUNTRY
COLLECTION



COUNTRY
COLLECTION

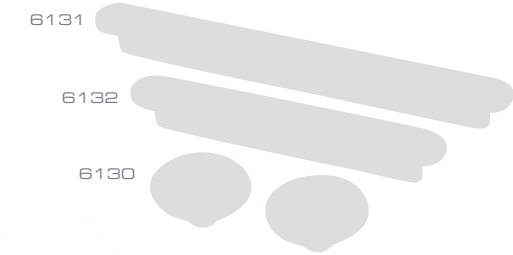

NEW PROVENCE

LAPS NEW



	▶mm◀	φmmφ	▶mm	∅mm	∅mm
6521	154	96	22	30	
8521				24	36

- 
805
 Latón cepillado rústico
 Laiton brossé rustique
 Rustic brushed brass
 Messing rustikal, gebürstet
- 
825
 Estaño cepillado
 Etain brossé
 Brushed tin
 Zinn gebürstet
- 
831
 Bronce rústico
 Bronze rustique
 Antique brass
 Bronze rustikal



	▶mm◀	φmmφ	▶mm	∅mm	∅mm
6131	222	192	22		21
6132	159	128	22		21
6130				45	23

- 
100
 Dorado brillo
 Doré brillant
 Gold plated
 Glänzend vergoldet
- 
400
 Cromo brillo
 Chromé brillant
 Bright chrome
 Glänzend verchromt
- 
500
 Níquel satinado
 Nickelé satiné
 Satin nickel
 Satiniertes Nickel
- 
831
 Bronce rústico
 Bronze rustique
 Antique brass
 Bronze rustikal
- 
836
 Estaño rústico
 Etain rustique
 Rustic tin
 Zinn rustikal

METAL / METAL / METALL

COUNTRY
COLLECTION



COUNTRY
COLLECTION

WAYS

ROUGH



	mm	mm	mm	mm	ZAMAK METAL METAL METALL
6170				45	25
6171	136	128	22		27

- 
400
 Cromo brillo
 Chromé brillant
 Bright chrome
 Glänzend verchromt
- 
500
 Níquel satinado
 Nickelé satiné
 Satin nickel
 Satiniertes Nickel
- 
831
 Bronce rústico
 Bronze rustique
 Antique brass
 Bronze rustikal
- 
836
 Estaño rústico
 Etain rustique
 Rustic tin
 Zinn rustikal

	mm	mm	mm	mm	mm	ZAMAK METAL METAL METALL
6150				25	42x42	
6151	169	128	25		27	
6152	127	96	23		26	

- 
400
 Cromo brillo
 Chromé brillant
 Bright chrome
 Glänzend verchromt
- 
500
 Níquel satinado
 Nickelé satiné
 Satin nickel
 Satiniertes Nickel
- 
831
 Bronce rústico
 Bronze rustique
 Antique brass
 Bronze rustikal
- 
836
 Estaño rústico
 Etain rustique
 Rustic tin
 Zinn rustikal



METAL / METAL / METAL / METALL

COUNTRY
COLLECTION



COUNTRY
COLLECTION

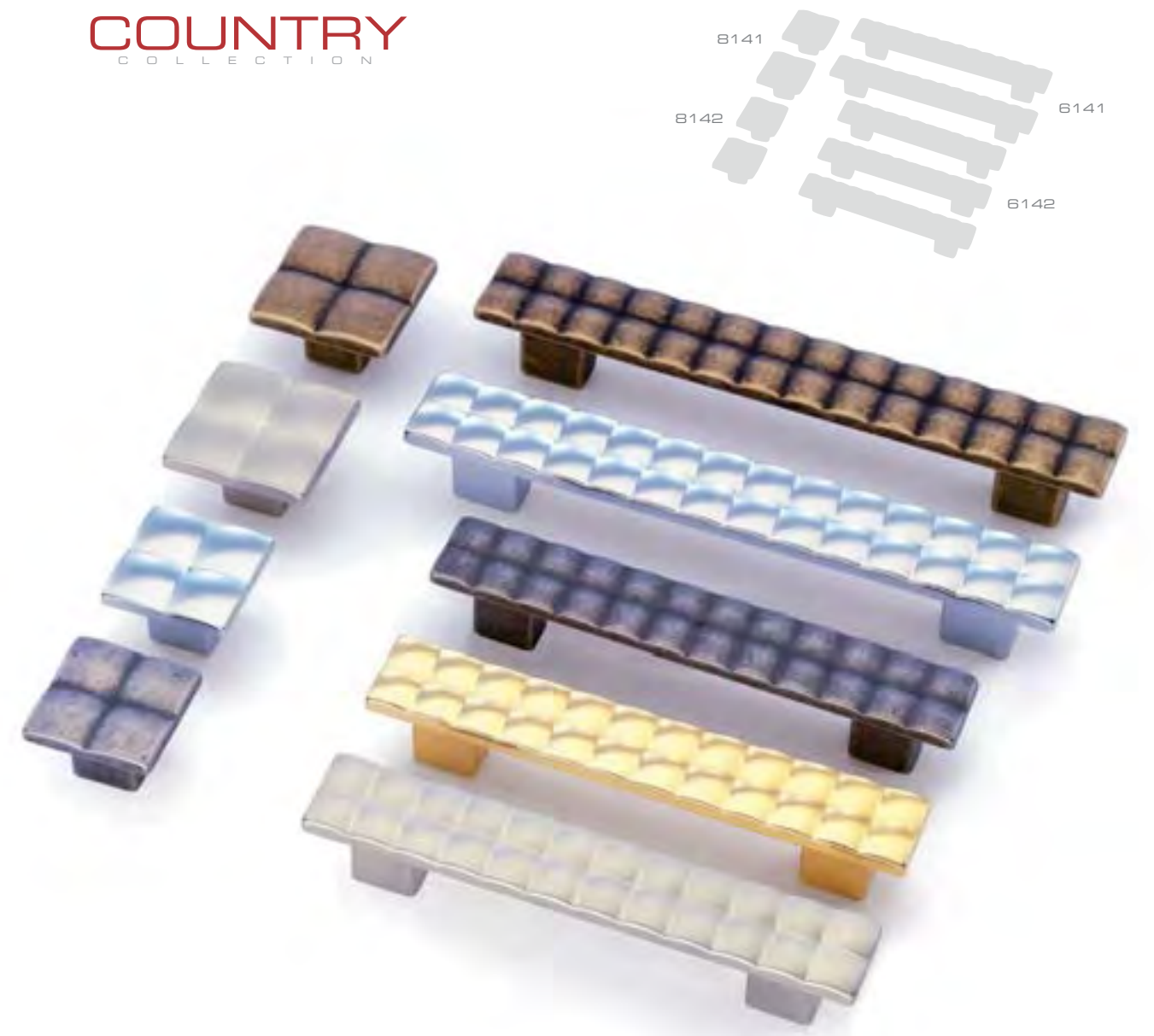

CROSS

CELL

	▶mm◀	φmmφ	▶mm	✂mm	⊘mm
6160			23		60x24
6161	136	128	30	27	
6162	104	96	28	27	

- 
400
 Cromo brillo
 Chromé brillant
 Bright chrome
 Glänzend verchromt
- 
500
 Níquel satinado
 Nickelé satiné
 Satin nickel
 Satiniertes Nickel
- 
831
 Bronce rústico
 Bronze rustique
 Antique brass
 Bronze rustikal
- 
836
 Estaño rústico
 Etain rustique
 Rustic tin
 Zinn rustikal

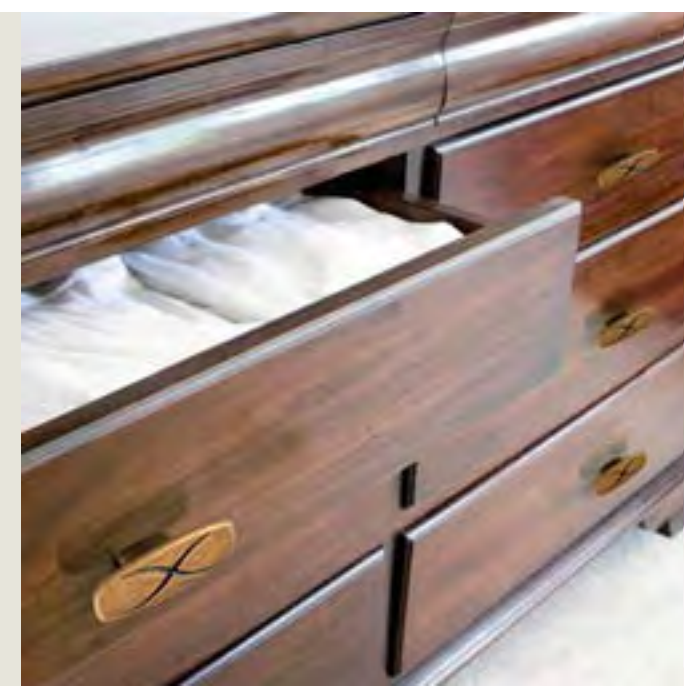

	▶mm◀	φmmφ	▶mm	✂mm	⊘mm
6141	167	128	25	26	
6142	131	96	22	25	
8141					24 38x38
8142					23 32x32

- 
100
 Dorado brillo
 Doré brillant
 Gold plated
 Glänzend vergoldet
- 
400
 Cromo brillo
 Chromé brillant
 Bright chrome
 Glänzend verchromt
- 
500
 Níquel satinado
 Nickelé satiné
 Satin nickel
 Satiniertes Nickel
- 
831
 Bronce rústico
 Bronze rustique
 Antique brass
 Bronze rustikal
- 
836
 Estaño rústico
 Etain rustique
 Rustic tin
 Zinn rustikal

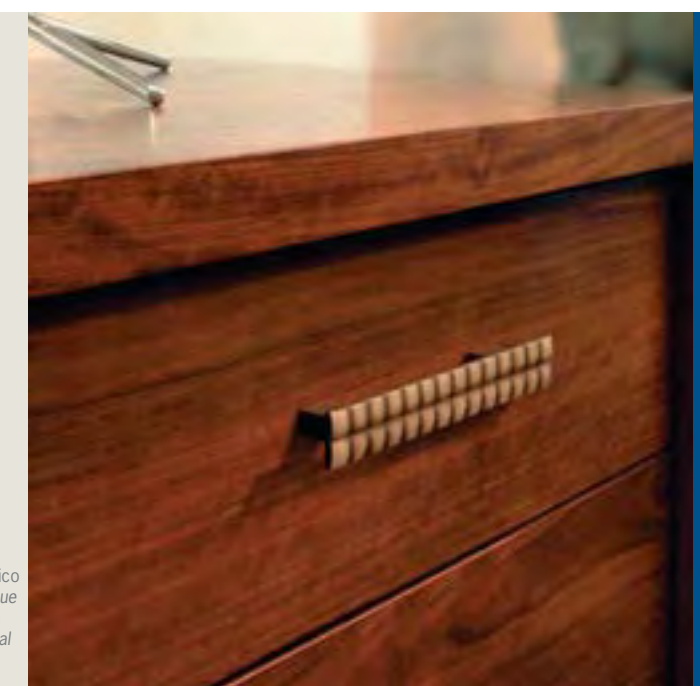

COUNTRY COLLECTION

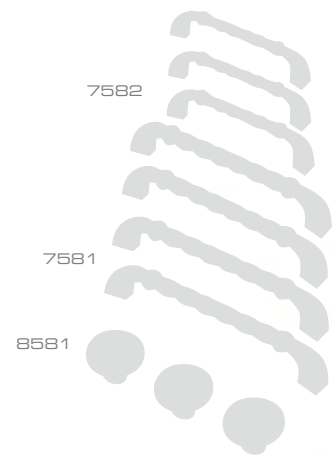

ROPE

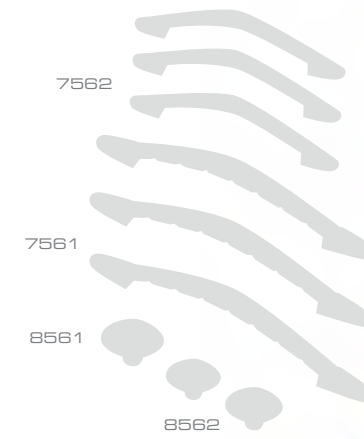

SPIRAL

COUNTRY COLLECTION



ZAMAK
METAL
METAL
METALL

	►mm◄	φmmφ	▶ mm	∅mm	✂mm
7581	150	128	15	30	
7582	114	96	13	27	
8581				34	23

- 

100
Dorado brillo
Doré brillant
Gold plated
Glänzend vergoldet
- 

500
Niquel satinado
Nickelé satiné
Satin nickel
Satiniertes Nickel
- 

810
Negro petróleo
Noir pétrole
Oil rubbed bronze
Ölgeschwätzte Bronze
- 

825
Estaño cepillado
Etain brossé
Brushed tin
Zinn gebürstet
- 

831
Bronce rústico
Bronze rustique
Antique brass
Bronze rustikal
- 

836
Estaño rústico
Etain rustique
Rustic tin
Zinn rustikal



ZAMAK
METAL
METAL
METALL

	►mm◄	φmmφ	▶ mm	✂mm	∅mm
7561	172	128	15	29	
7562	130	96	13	28	
8561				25	32x21
8562				22	28x18

- 

100
Dorado brillo
Doré brillant
Gold plated
Glänzend vergoldet
- 

500
Niquel satinado
Nickelé satiné
Satin nickel
Satiniertes Nickel
- 

810
Negro petróleo
Noir pétrole
Oil rubbed bronze
Ölgeschwätzte Bronze
- 

825
Estaño cepillado
Etain brossé
Brushed tin
Zinn gebürstet
- 

831
Bronce rústico
Bronze rustique
Antique brass
Bronze rustikal
- 

836
Estaño rústico
Etain rustique
Rustic tin
Zinn rustikal



COUNTRY

COLLECTION

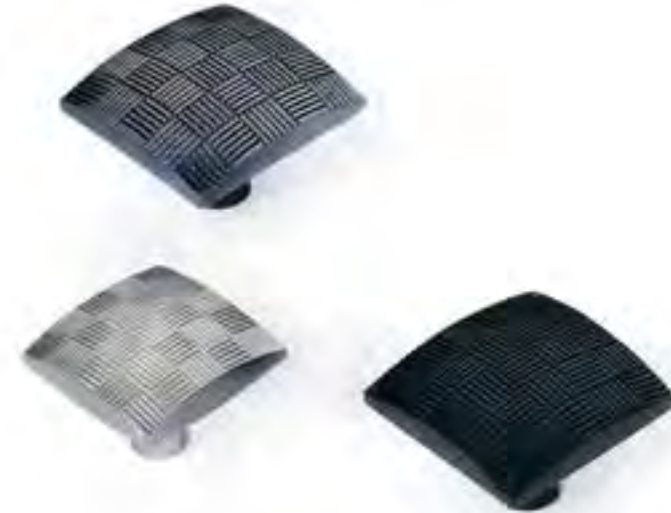

COUNTRY

COLLECTION

CHESS



	mm	mm	mm
7191	161	128	
7192	136	96	

ZAMAK
METAL
METAL
METALL



	mm	mm
8191	34x34	
8192	29x29	

ZAMAK
METAL
METAL
METALL

- 
100
 Dorado brillo
 Doré brillant
 Gold plated
 Glänzend vergoldet
- 
500
 Níquel satinado
 Nickelé satiné
 Satin nickel
 Satiniertes Nickel
- 
810
 Negro petróleo
 Noir pétrole
 Oil rubbed bronze
 Ölgeschwärzte Bronze
- 
825
 Estaño cepillado
 Etain brossé
 Brushed tin
 Zinn gebürstet
- 
831
 Bronce rústico
 Bronze rustique
 Antique brass
 Bronze rustikal
- 
836
 Estaño rústico
 Etain rustique
 Rustic tin
 Zinn rustikal



- 
100
 Dorado brillo
 Doré brillant
 Gold plated
 Glänzend vergoldet
- 
500
 Níquel satinado
 Nickelé satiné
 Satin nickel
 Satiniertes Nickel
- 
810
 Negro petróleo
 Noir pétrole
 Oil rubbed bronze
 Ölgeschwärzte Bronze
- 
825
 Estaño cepillado
 Etain brossé
 Brushed tin
 Zinn gebürstet
- 
831
 Bronce rústico
 Bronze rustique
 Antique brass
 Bronze rustikal
- 
836
 Estaño rústico
 Etain rustique
 Rustic tin
 Zinn rustikal

COUNTRY

COLLECTION



8491



7491
7492

COUNTRY

COLLECTION

REED

	▶mm◀	φmmφ	▶mm▶	Ømm	~mm
8491					35x30

ZAMAK
METAL
METAL
METALL

100 Dorado brillo Doré brillant Gold plated Glänzend vergoldet	500 Níquel satinado Nickel satiné Satin nickel	810 Negro petróleo Noir pétrole Oil rubbed bronze Ölgeschwärzte Bronze	825 Estaño cepillado Etain brossé Brushed tin Zinn gebürstet	831 Bronce rústico Bronze rustique Antique brass Bronze rustikal	836 Estaño rústico Etain rustique Rustic tin Zinn rustikal



	▶mm▶	φmmφ	▶mm▶	Ømm	~mm
7491	163		128		
7492	128		96		

ZAMAK
METAL
METAL
METALL

100 Dorado brillo Doré brillant Gold plated Glänzend vergoldet	500 Níquel satinado Nickel satiné Satin nickel	810 Negro petróleo Noir pétrole Oil rubbed bronze Ölgeschwärzte Bronze	825 Estaño cepillado Etain brossé Brushed tin Zinn gebürstet	831 Bronce rústico Bronze rustique Antique brass Bronze rustikal	836 Estaño rústico Etain rustique Rustic tin Zinn rustikal

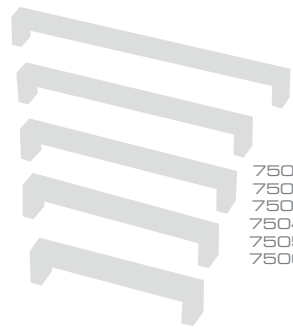

7501
7502
7503
7504
7505
7506



7950
7951
7952
7953
7954

UNIX



	▶mm◀	φmmφ	▶mm	Ømm	✂mm
7501	333	320	25	38	
7502	301	288	25	38	
7503	269	256	25	38	
7504	237	224	25	38	
7505	205	192	25	38	
7506	173	160	25	38	

031
Inoxidable cepillado
Inox brossé
Brushed stainless
Rostfreier Stahl, gebürstet

ACERO INOXIDABLE
ACIER INOX
STAINLESS STEEL
ROSTFREIER STAHL

	▶mm◀	φmmφ	▶mm	Ømm	φmm
7950	470	448	12		
7951	342	320	12		
7952	246	224	12		
7953	182	160	12		
7954	150	128	12		

431
Inoxidable cepillado/Cromo brillo
Inox brossé/Chromé brillant
Brushed stainless/Bright chrome
Rostfreier Stahl, gebürstet/Glänzend verchromt

ACERO INOXIDABLE-ZAMAK
ACIER INOX-METAL
STAINLESS STEEL-METAL
ROSTFREIER STAHL-METALL

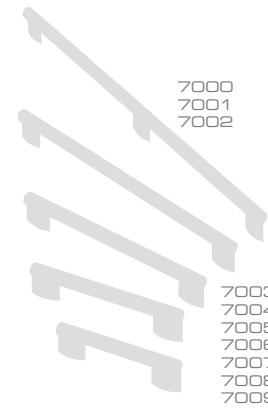

7000
7001
7002

7003
7004
7005
7006
7007
7008
7009

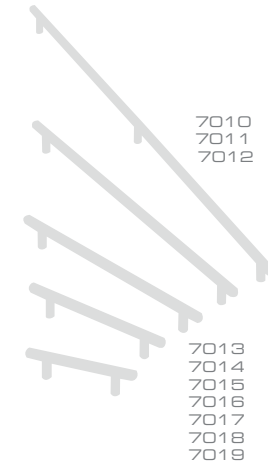

7010
7011
7012

7013
7014
7015
7016
7017
7018
7019



ACERO INOXIDABLE-ZAMAK
ACIER INOX-METAL
STAINLESS STEEL-METAL
ROSTFREIER STAHL-METALL

▶mm◀ ◊mm◊ ▶mm ◊mm ◊mm

7000	1310	1280	14
7001	926	896	14
7002	702	672	14
7003	478	448	14
7004	414	384	14
7005	318	288	14
7006	254	224	14
7007	222	192	14
7008	190	160	14
7009	158	128	14



031
Inoxidable cepillado
Inox brossé
Brushed stainless
Rostfreier Stahl, gebürstet



ACERO INOXIDABLE
ACIER INOX
STAINLESS STEEL
ROSTFREIER STAHL

▶mm◀ ◊mm◊ ▶mm ◊mm ◊mm

7010	1330	1280	12
7011	946	896	12
7012	722	672	12
7013	498	448	12
7014	434	384	12
7015	338	288	12
7016	274	224	12
7017	242	192	12
7018	210	160	12
7019	178	128	12



031
Inoxidable cepillado
Inox brossé
Brushed stainless
Rostfreier Stahl, gebürstet



7921

7922

7923

8922

8921

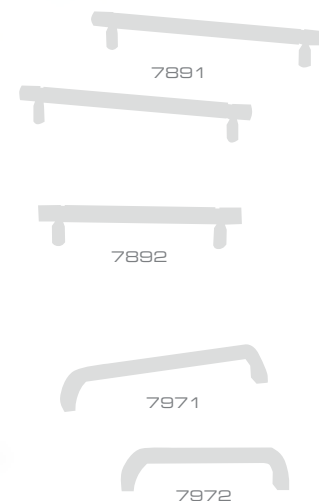

7891

7892

7971

7972



ACERO INOXIDABLE
ACIER INOX
STAINLESS STEEL
ROSTFREIER STAHL

▶mm◀ φmmφ ▶|◀mm Ømm ↻mm

7921	200	160	10
7922	166	128	10
7923	132	96	10
8921			18
8922			13



031
Inoxidable cepillado
Inox brossé
Brushed stainless
Rostfreier Stahl, gebürstet

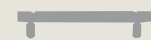

ACERO INOXIDABLE-ZAMAK
ACIER INOX-METAL
STAINLESS STEEL-METAL
ROSTFREIER STAHL-METALL

▶mm◀ φmmφ ▶|◀mm Ømm ↻mm

7891	152	128	10
7892	120	96	10



131
Inoxidable cepillado/Negro/Dorado brillo
Inox brossé/Noir/Doré brillant
Brushed stainless/Black/Gold plated
Rostfreier Stahl, gebürstet/Schwarz/Glänzend vergoldet



431
Inoxidable cepillado/Negro/Cromo brillo
Inox brossé/Noir/Chromé brillant
Brushed stainless/Black/Bright chrome
Rostfreier Stahl, gebürstet/Schwarz/Glänzend verchromt

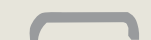

ACERO INOXIDABLE-ZAMAK
ACIER INOX-METAL
STAINLESS STEEL-METAL
ROSTFREIER STAHL-METALL

▶mm◀ φmmφ ▶|◀mm Ømm ↻mm

7971	139	128	10
7972	107	96	10



431
Inoxidable cepillado/Cromo brillo
Inox brossé/Chromé brillant
Brushed stainless/Bright chrome
Rostfreier Stahl, gebürstet/Glänzend verchromt

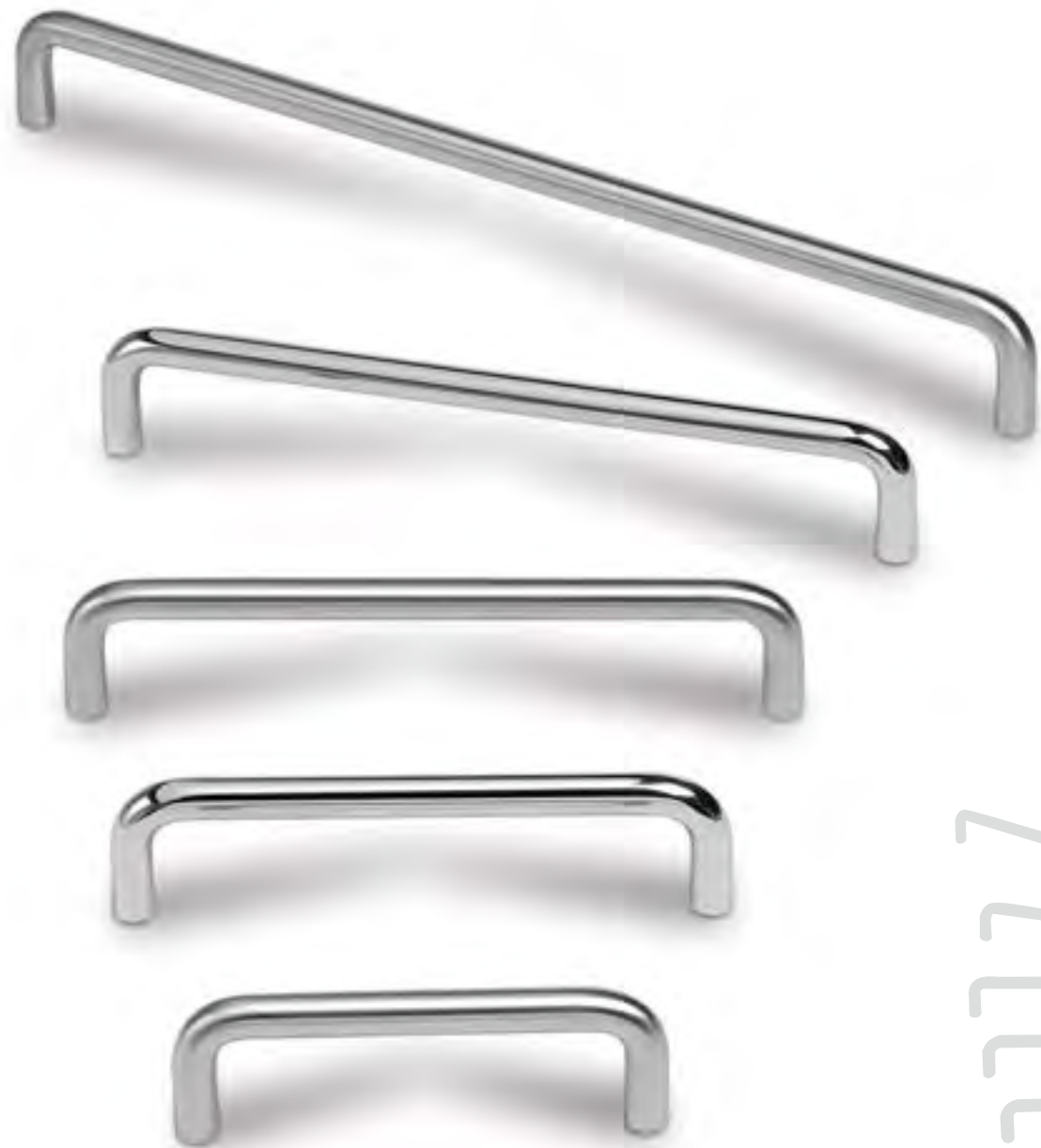

7810
7811
7812
7813
7814
7810
7811
7812
7813
7814



ACERO INOXIDABLE
ACIER INOX
STAINLESS STEEL
ROSTFREIER STAHL

▶mm◀ φmmϕ ▶|◀mm Ømm ⚭mm

7810	298	288	10	26
7811	202	192	10	25,5
7812	170	160	10	25,5
7813	138	128	10	25,5
7814	106	96	10	25
7810	200	192	8	21
7811	168	160	8	21
7812	136	128	8	21
7813	104	96	8	21
7814	72	64	8	21

031
Inoxidable cepillado
Inox brossé
Brushed stainless
Rostfreier Stahl, gebürstet

037
Inoxidable pulido
Inox poli brillant
Polished stainless
Rostfreier Stahl, hochglanz

ACERO INOXIDABLE
ACIER INOX
STAINLESS STEEL
ROSTFREIER STAHL

▶mm◀ φmmϕ ▶|◀mm Ømm ⚭mm

8361	30
8362	25
8363	20

031
Inoxidable cepillado
Inox brossé
Brushed stainless
Rostfreier Stahl, gebürstet

037
Inoxidable pulido
Inox poli brillant
Polished stainless
Rostfreier Stahl, hochglanz

ACERO INOXIDABLE
ACIER INOX
STAINLESS STEEL
ROSTFREIER STAHL

▶mm◀ φmmϕ ▶|◀mm Ømm ⚭mm

7861	145	128	10
7862	110	96	10

031
Inoxidable cepillado
Inox brossé
Brushed stainless
Rostfreier Stahl, gebürstet

INDICE / INDEX

Pag. / Ref. / Materia prima - Matière Première - Raw Material - Rohmaterial

87	5001	Poli Dur / Poli Dur / Poli Dur / Poli Dur	83	5605	Aluminio y Resina de poliéster / Aluminium et Résine polyester / Aluminium and Polyester Resin / Aluminium und Polyesterharz	84	5628	Nylon / Nylon / Nylon / Nylon
87	5002	Poli Dur / Poli Dur / Poli Dur / Poli Dur			Aluminium et Résine polyester / Aluminium and Polyester Resin / Aluminium und Polyesterharz	84	5629	Nylon / Nylon / Nylon / Nylon
86	5101	Poli Dur-Zamak / Poli Dur-Metal / Poli Dur-Metal / Poli Dur-Metall	83	5606	Aluminio y Resina de poliéster / Aluminium et Résine polyester / Aluminium and Polyester Resin / Aluminium und Polyesterharz	81	5981	Metacrilato-Zamak / Methacrylate-Metal / Methacrylate-Metall
86	5102	Poli Dur-Zamak / Poli Dur-Metal / Poli Dur-Metal / Poli Dur-Metall			Aluminium et Résine polyester / Aluminium and Polyester Resin / Aluminium und Polyesterharz	81	5982	Metacrilato-Zamak / Methacrylate-Metal / Methacrylate-Metall
87	5201	Poli Dur-Zamak / Poli Dur-Metal / Poli Dur-Metal / Poli Dur-Metall	83	5607	Aluminio y Resina de poliéster / Aluminium et Résine polyester / Aluminium and Polyester Resin / Aluminium und Polyesterharz			Methacrylate-Metal / Methacrylate-Metall
87	5202	Poli Dur-Zamak / Poli Dur-Metal / Poli Dur-Metal / Poli Dur-Metall			Aluminium et Résine polyester / Aluminium and Polyester Resin / Aluminium und Polyesterharz	81	5983	Metacrilato-Zamak / Methacrylate-Metal / Methacrylate-Metall
87	5221	Poli Dur / Poli Dur / Poli Dur / Poli Dur	83	5608	Aluminio y Resina de poliéster / Aluminium et Résine polyester / Aluminium and Polyester Resin / Aluminium und Polyesterharz			Methacrylate-Metal / Methacrylate-Metall
87	5222	Poli Dur / Poli Dur / Poli Dur / Poli Dur			Aluminium et Résine polyester / Aluminium and Polyester Resin / Aluminium und Polyesterharz			
83	5601	Aluminio y Resina de poliéster / Aluminium et Résine polyester / Aluminium and Polyester Resin / Aluminium und Polyesterharz	85	5611	Nylon / Nylon / Nylon / Nylon			
			85	5612	Nylon / Nylon / Nylon / Nylon			
			85	5613	Nylon / Nylon / Nylon / Nylon			
			85	5614	Nylon / Nylon / Nylon / Nylon			
83	5602	Aluminio y Resina de poliéster / Aluminium et Résine polyester / Aluminium and Polyester Resin / Aluminium und Polyesterharz	84	5615	Nylon / Nylon / Nylon / Nylon			
			84	5616	Nylon / Nylon / Nylon / Nylon			
			84	5617	Nylon / Nylon / Nylon / Nylon			
			84	5618	Nylon / Nylon / Nylon / Nylon			
83	5603	Aluminio y Resina de poliéster / Aluminium et Résine polyester / Aluminium and Polyester Resin / Aluminium und Polyesterharz	84	5619	Nylon / Nylon / Nylon / Nylon			
			85	5621	Nylon / Nylon / Nylon / Nylon			
			85	5622	Nylon / Nylon / Nylon / Nylon			
			85	5623	Nylon / Nylon / Nylon / Nylon			
83	5604	Aluminio y Resina de poliéster / Aluminium et Résine polyester / Aluminium and Polyester Resin / Aluminium und Polyesterharz	84	5624	Nylon / Nylon / Nylon / Nylon			
			84	5625	Nylon / Nylon / Nylon / Nylon			
			85	5626	Nylon / Nylon / Nylon / Nylon			
			84	5627	Nylon / Nylon / Nylon / Nylon			

RESINS AND LACQUERED / HARZ UND LACK



RESINAS Y LACADOS / RÉSINES ET LAQUÉS





5981



5982

5983

ACRYLIC



METACRILATO-ZAMAK
METHACRYLATE-METAL
METHACRYLATE-METAL
METHACRYLATE-METALL

▶mm◀ φmm▶ ▶mm Ømm ⅓mm

5981	240	192-160	28	27
5982	175	128-96	28	27
5983	65	16	28	27



300

Níquel cepillado/Transparente
Nickelé brossé/Transparent
Brushed nickel/Transparent
Gebürstetes Nickel/Transparent



302

Níquel cepillado/Blanco
Nickelé brossé/Blanc
Brushed nickel/White
Gebürstetes Nickel/Weiß



333

Níquel cepillado/Negro
Nickelé brossé/Noir
Brushed nickel/Black
Gebürstetes Nickel/Schwarz



369

Níquel cepillado/Naranja
Nickelé brossé/Orange
Brushed nickel/Orange
Gebürstetes Nickel/Orange

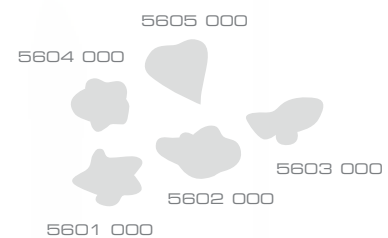

JUNIOR
LINE

JUNIOR

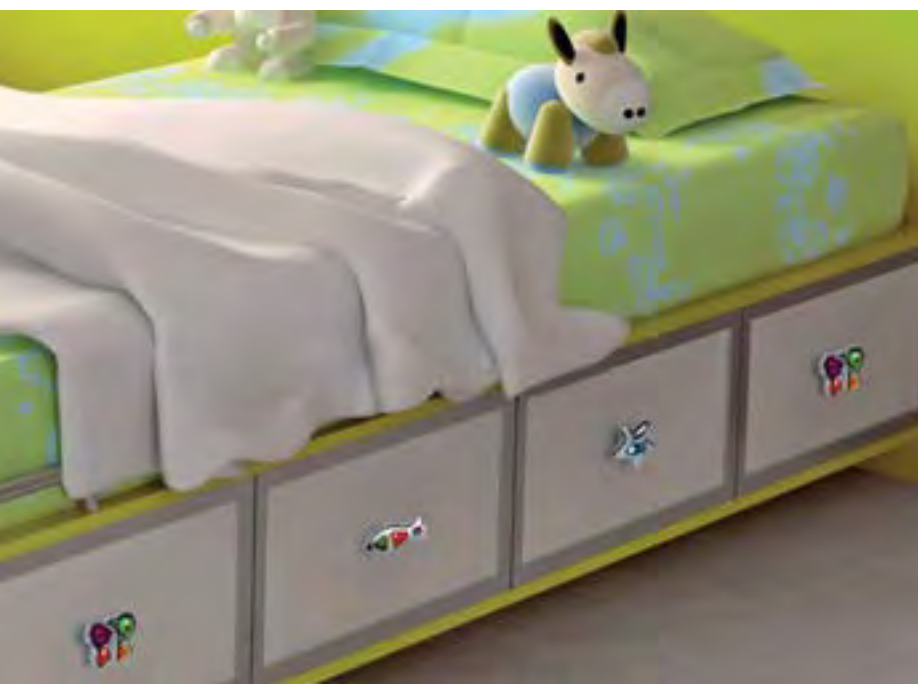

ALUMINIO Y RESINA POLIÉSTER
ALUMINIUM ET RÉSINE POLYESTER
ALUMINIUM AND POLYESTER RESIN
ALUMINIUM UND POLYESTERHARZ

	mm	mm
5601 000	45x45	25
5602 000	50x45	25
5603 000	50x25	25
5604 000	35x35	20
5605 000	42x50	32
5606 000	50x50	28
5607 000	47x38	28
5608 000	45x47	28



KIDLINE
COLLECTION

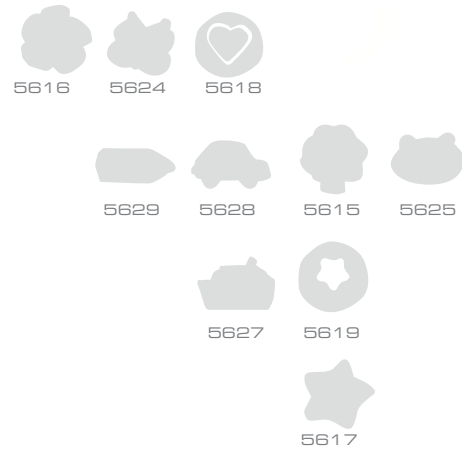

KIDLINE
COLLECTION

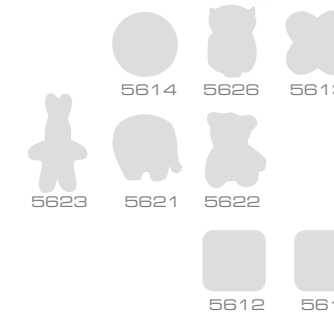

NEW

	▶mm◀	⌀mm⊕	▶mm▶	∅mm	⌀mm
5615	47		51		
5616				50	
5617				50	
5618	50		48		
5619				50	
5624	45		42		
5625	51		35		
5627	50		35		
5628	50		31		
5629	22		40		

NYLON
NYLON
NYLON
NYLON



NEW

	▶mm◀	⌀mm⊕	▶mm▶	∅mm	⌀mm
5611	40		40		
5612	40		40		
5613	43		43		
5614				50	
5621	44		41		
5622	38		47		
5623	35		58		
5626	34		49		

NYLON
NYLON
NYLON
NYLON

RESINAS Y LACADOS / RÉSINES ET LAQUÉS
RESINS AND LACQUERED / HARZ UND LACK



5101

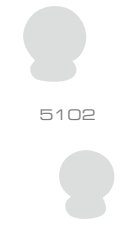

5102

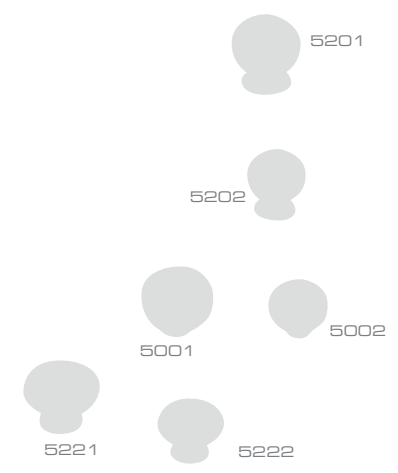

5201

5202

5001

5002

5221

5222



POLI DUR-ZAMAK
POLI DUR-METAL
POLI DUR-METAL
POLI DUR-METALL

►mm◄ φmmφ ►|◄mm Ømm ↻mm

5101	34
5102	28



POLI DUR
POLI DUR
POLI DUR
POLI DUR

►mm◄ φmmφ ►|◄mm Ømm ↻mm

5001	34
5002	28
5221	37
5222	32



POLI DUR-ZAMAK
POLI DUR-METAL
POLI DUR-METAL
POLI DUR-METALL

►mm◄ φmmφ ►|◄mm Ømm ↻mm

5201	34
5202	28



102

Blanco/Dorado brillo
Blanc/Doré brillant
White/Gold plated
Weiß/Glänzend vergoldet



133

Negro brillo/Dorado brillo
Noir brillant/Doré brillant
Bright black/Gold plated
Glänzend schwarz/Glänzend vergoldet



002

Blanco
Blanc
White
Weiß



033

Negro brillo
Noir brillant
Bright black
Glänzend schwarz



002

Blanco
Blanc
White
Weiß



033

Negro brillo
Noir brillant
Bright black
Glänzend schwarz

WOOD / HOLZ

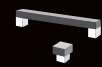

MADERA / BOIS



INDICE / INDEX

Pag. / Ref. / Materia prima - Matière Première - Raw Material - Rohmaterial

93	9062	Madera / Bois / Wood / Holz	90	9382	Madera-Zamak / Bois-Metal / Wood-Metal / Holz-Metall
93	9063	Madera / Bois / Wood / Holz			
91	9090	Madera-Zamak / Bois-Metal / Wood-Metal / Holz-Metall	90	9383	Madera-Zamak / Bois-Metal / Wood-Metal / Holz-Metall
90	9381	Madera-Zamak / Bois-Metal / Wood-Metal / Holz-Metall	92	9390	Madera / Bois / Wood / Holz
			92	9391	Madera / Bois / Wood / Holz

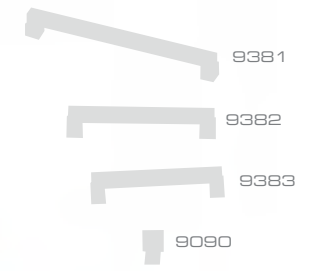



SYMBIOSIS





	▶mm◀	φmmφ	▶mm▶	✂mm✂	⊘mm
9381	208	192	12	29	
9382	176	160	12	29	
9383	144	128	12	29	

	▶mm▶	φmmφ	▶mm▶	✂mm✂	⊘mm
9090	21x21				29

 800 Cromo mate/Fresno, barniz wengue
 Chromé mat/Frêne, vernis wengue
 Dull chrome/Ash tree, wengue varnish
 Matt verchromt/Esche, Wenge lackiert

 815 Cromo mate/Haya, barniz transparente
 Chromé mat/Hêtre, vernis transparent
 Dull chrome/Beech, transparent varnish
 Chrom matt/Buche, transparentlackiert

 800 Cromo mate/Fresno, barniz wengue
 Chromé mat/Frêne, vernis wengue
 Dull chrome/Ash tree, wengue varnish
 Matt verchromt/Esche, Wenge lackiert

 815 Cromo mate/Haya, barniz transparente
 Chromé mat/Hêtre, vernis transparent
 Dull chrome/Beech, transparent varnish
 Chrom matt/Buche, transparentlackiert

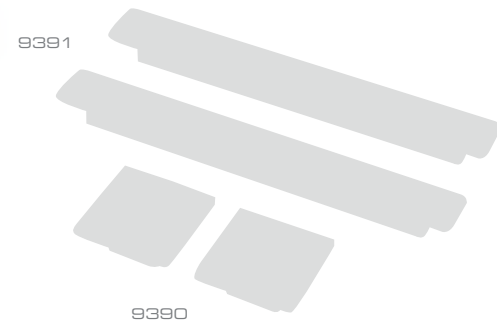

NATURE



	▶mm◀	⌀mm⌀	▶◀mm	✂mm
9390	55	16	55	22
9391	240	192	30	22

	▶mm◀	⌀mm⌀	▶◀mm	Ømm	⌀mm
9062				40	
9063				30	

046
Wengué
Wengué
Wengue
Wenge

047
Marrón claro
Brun clair
Light Brown
Hellbraun

014
Haya, sin barniz
Hêtre, non verni
Beech, unvarnished
Buche, unlackiert

015
Haya, barniz transparente
Hêtre, vernis transparent
Beech, transparent varnish
Buche, transparentlackiert

016
Haya, barniz nogal
Hêtre, vernis noyer
Beech, walnut varnish
Buche, Nußbaum lackiert

025
Pino, barniz transparente
Pin, vernis transparent
Pine, transparent varnish
Kiefer, transparentlackiert

035
Roble, barniz transparente
Chêne, vernis transparent
Oak, transparent varnish
Eiche, transparentlackiert

PORCELAIN / PORZELLAN



PORCELANA / PORCELAINE



INDICE / INDEX

Pag. / Ref. / Materia prima - Matière Première - Raw Material - Rohmaterial

101	9501	Porcelana-Zamak / Porcelaine-Metal / Porcelain-Metal / Porzellan-Metall	99	9682	Porcelana / Porcelaine / Porcelain / Porzellan	96	9841	Porcelana-Zamak / Porcelaine-Metal / Porcelain-Metal / Porzellan-Metall
101	9502	Porcelana-Zamak / Porcelaine-Metal / Porcelain-Metal / Porzellan-Metall	98	9700	Porcelana-Zamak / Porcelaine-Metal / Porcelain-Metal / Porzellan-Metall	96	9842	Porcelana-Zamak / Porcelaine-Metal / Porcelain-Metal / Porzellan-Metall
100	9531	Porcelana-Zamak / Porcelaine-Metal / Porcelain-Metal / Porzellan-Metall	97	9770	Porcelana-Zamak / Porcelaine-Metal / Porcelain-Metal / Porzellan-Metall	96	9851	Porcelana-Zamak / Porcelaine-Metal / Porcelain-Metal / Porzellan-Metall
100	9532	Porcelana-Zamak / Porcelaine-Metal / Porcelain-Metal / Porzellan-Metall	97	9771	Porcelana-Zamak / Porcelaine-Metal / Porcelain-Metal / Porzellan-Metall	96	9852	Porcelana-Zamak / Porcelaine-Metal / Porcelain-Metal / Porzellan-Metall
100	9533	Porcelana-Zamak / Porcelaine-Metal / Porcelain-Metal / Porzellan-Metall	97	9772	Porcelana-Zamak / Porcelaine-Metal / Porcelain-Metal / Porzellan-Metall			
101	9551	Porcelana-Zamak / Porcelaine-Metal / Porcelain-Metal / Porzellan-Metall	96	9821	Porcelana-Zamak / Porcelaine-Metal / Porcelain-Metal / Porzellan-Metall			
101	9552	Porcelana-Zamak / Porcelaine-Metal / Porcelain-Metal / Porzellan-Metall	96	9822	Porcelana-Zamak / Porcelaine-Metal / Porcelain-Metal / Porzellan-Metall			
99	9651	Porcelana / Porcelaine / Porcelain / Porzellan			96	9831	Porcelana-Zamak / Porcelaine-Metal / Porcelain-Metal / Porzellan-Metall	
99	9652	Porcelana / Porcelaine / Porcelain / Porzellan	96	9832	Porcelana-Zamak / Porcelaine-Metal / Porcelain-Metal / Porzellan-Metall			
99	9681	Porcelana / Porcelaine / Porcelain / Porzellan						



9822

9842

9821

9841



9831

9832

9852

9851



9770

9771

9772



PORCELANA-ZAMAK
PORCELAINE-METAL
PORCELAIN-METAL
PORZELLAN-METALL

▶mm◀ ◊mm◊ ▶◄mm ◊mm ◊mm

9821	178	128	22
9822	137	96	20
9831			34
9832			28



PORCELANA-ZAMAK
PORCELAINE-METAL
PORCELAIN-METAL
PORZELLAN-METALL

▶mm◀ ◊mm◊ ▶◄mm ◊mm ◊mm

9841	178	128	22
9842	137	96	20
9851			34
9852			28



PORCELANA-ZAMAK
PORCELAINE-METAL
PORCELAIN-METAL
PORZELLAN-METALL

▶mm◀ ◊mm◊ ▶◄mm ◊mm ◊mm

9770	110	96	15
9771			37
9772			30



805

Craquelé/Latón cepillado rústico
Craquelé/Laiton brossé rustique
Craquelé/Rustic brushed brass
Craquelé/Messing rustikal, gebürstet



831

Craquelé/Bronze rústico
Craquelé/Bronze rustique
Craquelé/Antique brass
Craquelé/Bronze rustikal



831

Marfil, decorada/Bronze rústico
Ivoire, décorée/Bronze rustique
Ivory, decorated/Antique brass
Elfenbein, dekoriert/Bronze rustikal



109

Marfil, decorada/Dorado brillo
Ivoire, décorée/Doré brillant
Ivory, decorated/Gold plated
Elfenbein, dekoriert/Glänzend vergoldet



831

Marfil, decorada/Bronze rústico
Ivoire, décorée/Bronze rustique
Ivory, decorated/Antique brass
Elfenbein, dekoriert/Bronze rustikal



836

Marfil, decorada/Estaño rústico
Ivoire, décorée/Étain rustique
Ivory, decorated/Rustic tin
Elfenbein, dekoriert/Zinn rustikal



809

Marfil, decorada/Bronze viejo
Ivoire, décorée/Vieux bronze
Ivory, decorated/Old bronze
Elfenbein, dekoriert/Antik bronziert

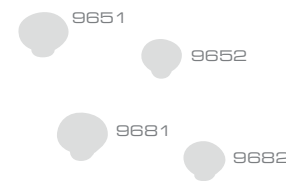

	▶mm◀	φmmφ	▶mm	Ømm	~mm
9700	110	96		15	

PORCELANA-ZAMAK
PORCELAINE-MÉTAL
PORCELAIN-MÉTAL
PORZELLAN-METALL

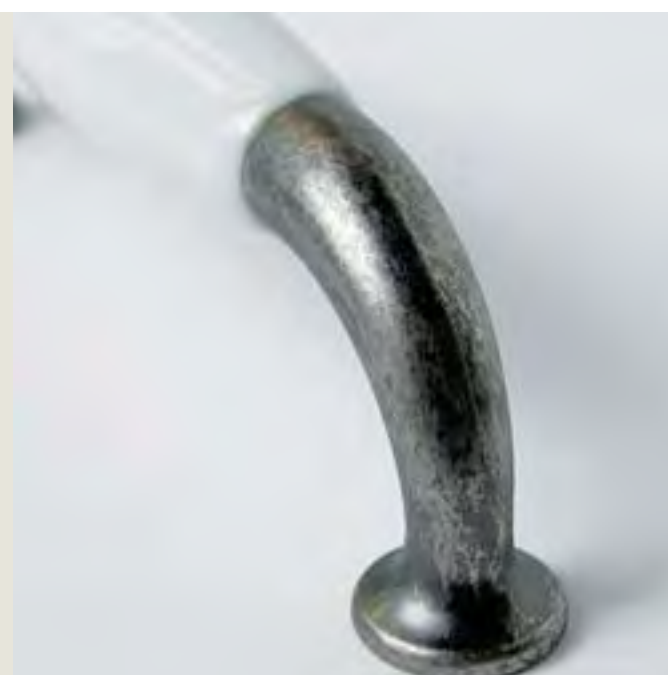

	▶mm◀	φmmφ	▶mm	Ømm	~mm
9651				38	
9652				32	

PORCELANA
PORCELAINE
PORCELAIN
PORZELLAN

	▶mm◀	φmmφ	▶mm	Ømm	~mm
9681				38	
9682				32	

PORCELANA
PORCELAINE
PORCELAIN
PORZELLAN

- 
102
 Blanca/Dorado brillo
 Blanche/Doré brillant
 White/Gold plated
 Weiß/Glänzend vergoldet
- 
836
 Blanca/Estaño rústico
 Blanche/Etain rustique
 White/Rustic tin
 Weiß/Zinn rustikal
- 
902
 Blanca/Bronce viejo
 Blanche/Vieux bronze
 White/Old bronze
 Weiß/Antik bronziert

- 
002
 Blanca
 Blanche
 White
 Weiß

- 
057
 Blanca, flor azul
 Blanche, fleur bleue
 White, blue flower
 Weiß, blaue Blume

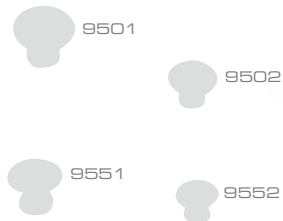

	►mm◄	φmmφ	▶ ◄mm	Ømm	↺mm
9531				37	
9532				30	
9533				25	

PORCELANA-ZAMAK
PORCELAINE-MÉTAL
PORCELAIN-MÉTAL
PORZELLAN-METALL

	►mm◄	φmmφ	▶ ◄mm	Ømm	↺mm
9501				37	
9502				30	

PORCELANA-ZAMAK
PORCELAINE-MÉTAL
PORCELAIN-MÉTAL
PORZELLAN-METALL

	►mm◄	φmmφ	▶ ◄mm	Ømm	↺mm
9551				37	
9552				30	

PORCELANA-ZAMAK
PORCELAINE-MÉTAL
PORCELAIN-MÉTAL
PORZELLAN-METALL



100

Blanca, decorada/Dorado brillo
Blanche, décorée/Doré brillant
White, decorated/Gold plated
Weiß, dekoriert/Glänzend vergoldet



102

Blanca/Dorado brillo
Blanche/Doré brillant
White/Gold plated
Weiß/Glänzend vergoldet



102

Blanca/Dorado brillo
Blanche/Doré brillant
White/Gold plated
Weiß/Glänzend vergoldet



902

Blanca/Bronce viejo
Blanche/Vieux bronze
White/Old bronze
Weiß/Antik bronziert

CRYSTAL / KRISTALL

CRYSTAL / KRISTALL



INDICE / INDEX

Pag. / Ref. / Materia prima - Matière Première - Raw Material - Rohmaterial

106	9912	Cristal-Latón / Cristal-Laiton / Crystall-Brass / Kristall-Messing	105	9952	Cristal "Strass"-Zamak / Cristal "Strass"-Metal / "Strass" Crystall-Metal / "Strass"-Kristall-Metall	104	9991	Cristal-Latón / Cristal-Laiton / Crystall-Brass / Kristall-Messing
106	9913	Cristal-Latón / Cristal-Laiton / Crystall-Brass / Kristall-Messing	105	9953	Cristal "Strass"-Zamak / Cristal "Strass"-Metal / "Strass" Crystall-Metal / "Strass"-Kristall-Metall	104	9992	Cristal-Latón / Cristal-Laiton / Crystall-Brass / Kristall-Messing
105	9932	Cristal "Strass"-Latón / Cristal "Strass"-Laiton / "Strass" Crystall-Brass / "Strass"-Kristall-Messing	107	9982	Cristal-Latón / Cristal-Laiton / Crystall-Brass / Kristall-Messing	107	9983	Cristal-Latón / Cristal-Laiton / Crystall-Brass / Kristall-Messing
105	9933	Cristal "Strass"-Latón / Cristal "Strass"-Laiton / "Strass" Crystall-Brass / "Strass"-Kristall-Messing						

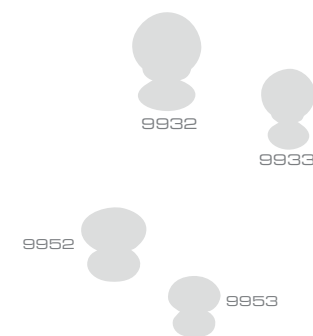
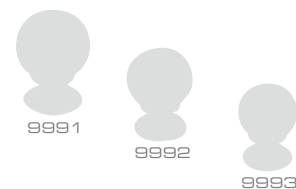

MADE WITH SWAROVSKI® ELEMENTS

MADE WITH SWAROVSKI® ELEMENTS

	▶mm◀	φmmφ	▶mm	Ømm	↻mm
9991				35	
9992				30	
9993				25	

	▶mm◀	φmmφ	▶mm	Ømm	↻mm
9932				30	
9933				20	

	▶mm◀	φmmφ	▶mm	Ømm	↻mm
9952				30	
9953				25	

100
Transparente/Dorado brillo
Transparent/Doré brillant
Transparent/Gold plated
Transparent/Glänzend vergoldet

100
Transparente/Dorado brillo
Transparent/Doré brillant
Transparent/Gold plated
Transparent/Glänzend vergoldet

400
Transparente/Cromo brillo
Transparent/Chromé brillant
Transparent/Bright chrome
Transparent/Glänzend verchromt

100
Transparente/Dorado brillo
Transparent/Doré brillant
Transparent/Gold plated
Transparent/Glänzend vergoldet

400
Transparente/Cromo brillo
Transparent/Chromé brillant
Transparent/Bright chrome
Transparent/Glänzend verchromt

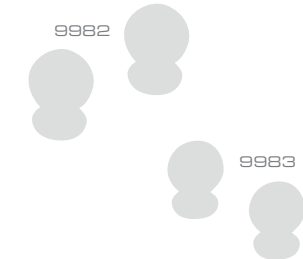
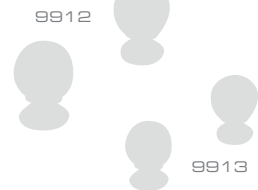

CRISTAL-LATÓN
CRISTAL-LAITON
CRYSTAL-BRASS
KRISTALL-MESSING

►mm◄ φmmφ ►◄mm Ømm ↺mm

9912	30
9913	25



CRISTAL-LATÓN
CRISTAL-LAITON
CRYSTAL-BRASS
KRISTALL-MESSING

►mm◄ φmmφ ►◄mm Ømm ↺mm

9982	30
9983	25



100

Transparente/Dorado brillo
Transparent/Doré brillant
Transparent/Gold plated
Transparent/Glänzend vergoldet



400

Transparente/Cromo brillo
Transparent/Chromé brillant
Transparent/Bright chrome
Transparent/Glänzend verchromt



100

Transparente/Dorado brillo
Transparent/Doré brillant
Transparent/Gold plated
Transparent/Glänzend vergoldet



400

Transparente/Cromo brillo
Transparent/Chromé brillant
Transparent/Bright chrome
Transparent/Glänzend verchromt

INDICE / INDEX

Pag. / Ref. / Materia prima - Matière Première - Raw Material - Rohmaterial

127	ED-15	Hierro / Fer / Iron / Eisen	117	3500	Zamak / Metal / Metal / Metall	118	3702	Zamak / Metal / Metal / Metall
126	M-45	Hierro / Fer / Iron / Eisen	124	3502	Latón / Laiton / Brass / Messing	118	3703	Zamak / Metal / Metal / Metall
127	T-14	Hierro / Fer / Iron / Eisen	124	3503	Latón / Laiton / Brass / Messing	115	3710	Zamak / Metal / Metal / Metall
127	T-21	Hierro / Fer / Iron / Eisen	117	3510	Zamak / Metal / Metal / Metall	114	3720	Zamak / Metal / Metal / Metall
127	T-25	Hierro / Fer / Iron / Eisen	117	3511	Zamak / Metal / Metal / Metall	114	3730	Zamak / Metal / Metal / Metall
127	T-31	Hierro / Fer / Iron / Eisen	122	3511	Zamak / Metal / Metal / Metall	114	3740	Zamak / Metal / Metal / Metall
127	T-35	Hierro / Fer / Iron / Eisen	117	3512	Zamak / Metal / Metal / Metall	111	3750	Zamak / Metal / Metal / Metall
127	T-40	Hierro / Fer / Iron / Eisen	122	3512	Zamak / Metal / Metal / Metall	123	3801	Latón-Hierro / Laiton-Fer / Brass-Iron / Messing-Eisen
127	T-60	Hierro / Fer / Iron / Eisen	113	3530	Zamak / Metal / Metal / Metall	123	3802	Latón-Hierro / Laiton-Fer / Brass-Iron / Messing-Eisen
127	231	Nylon / Nylon / Nylon / Nylon	113	3531	Zamak / Metal / Metal / Metall	123	3900	Zamak-Plástico / Metal- Plastique / Metal-Plastic / Metall-Kunststoff
127	232	Nylon / Nylon / Nylon / Nylon	113	3532	Zamak / Metal / Metal / Metall	122	3921	Zamak / Metal / Metal / Metall
125	2000	Zamak / Metal / Metal / Metall	113	3533	Zamak / Metal / Metal / Metall	122	3922	Zamak / Metal / Metal / Metall
125	2810	Zamak / Metal / Metal / Metall	110	3541	Zamak / Metal / Metal / Metall	123	3930	Zamak-Plástico / Metal- Plastique / Metal-Plastic / Metall-Kunststoff
121	3251	Zamak / Metal / Metal / Metall	110	3542	Zamak / Metal / Metal / Metall	119	3940	Zamak / Metal / Metal / Metall
121	3252	Zamak / Metal / Metal / Metall	124	3552	Latón-Hierro / Laiton-Fer / Brass-Iron / Messing-Eisen	118	3701	Zamak / Metal / Metal / Metall
120	3261	Zamak / Metal / Metal / Metall	116	3560	Zamak / Metal / Metal / Metall			
120	3262	Zamak / Metal / Metal / Metall	116	3561	Zamak / Metal / Metal / Metall			
121	3271	Zamak / Metal / Metal / Metall	116	3562	Zamak / Metal / Metal / Metall			
121	3272	Zamak / Metal / Metal / Metall	116	3600	Zamak / Metal / Metal / Metall			
112	3281	Zamak / Metal / Metal / Metall	116	3600	Zamak / Metal / Metal / Metall			
112	3282	Zamak / Metal / Metal / Metall	118	3701	Zamak / Metal / Metal / Metall			



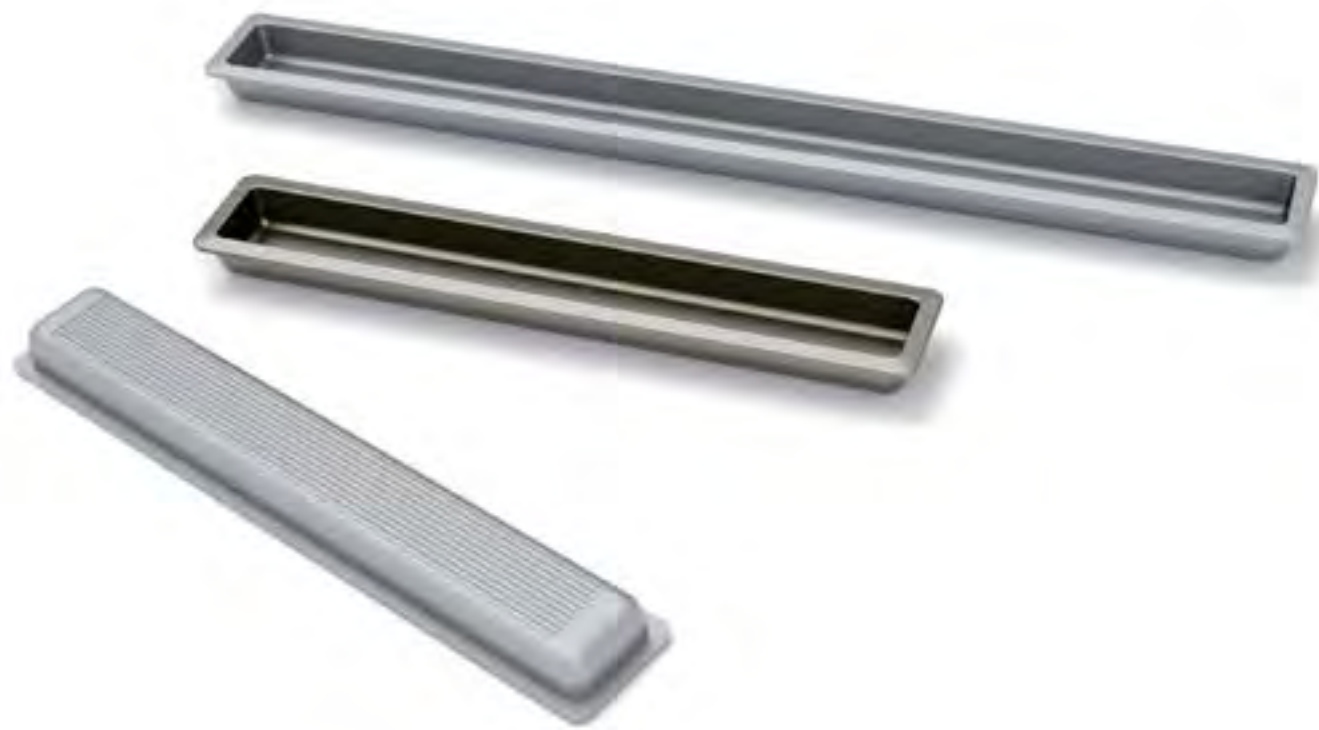

NEW SLIM

STRAIGHT NEW



	▶mm◀	▶mm◀	mm	mm	mm
3541	240	25	237x22	10.7	
3542	150	25	147x22	10.7	

- Inox look**
- 038**
Níquel cepillado
Nickelé brossé
Brushed nickel
Gebürstetes Nickel
- 800**
Cromo mate
Chromé mat
Dull chrome
Matt verchromt

	▶mm◀	mm	mm	mm	mm
3750	202	192	55	199x52	14

- 800**
Cromo mate
Chromé mat
Dull chrome
Matt verchromt





ARTTECH
COLLECTION

UP



ARTTECH
COLLECTION

PUSH



	▶mm◀	φmmφ	▶◀mm	✂mm
3281	90	64	10	50
3282	42	16	10	74

ZAMAK
METAL
METAL
METALL

002 Blanco Blanc White Weiß	Inox look 038 Niquel cepillado Nickelé brossé Brushed nickel Gebürstetes Nickel	400 Cromo brillo Chromé brillant Bright chrome Glänzend verchromt	500 Niquel mate Nickelé mat Dull nickel Matt Nickel	800 Cromo mate Chromé mat Dull chrome Matt verchromt
---	---	---	---	--

	▶mm◀	Ømm	▶mm	✂mm
3530	74.7	69.5	11.1	
3531	63.8	59.5	11.3	
3532	49	44.5	10.9	
3533	39.8	34.8	11.2	

ZAMAK
METAL
METAL
METALL

Inox look 038 Niquel cepillado Nickelé brossé Brushed nickel Gebürstetes Nickel	800 Cromo mate Chromé mat Dull chrome Matt verchromt
---	--

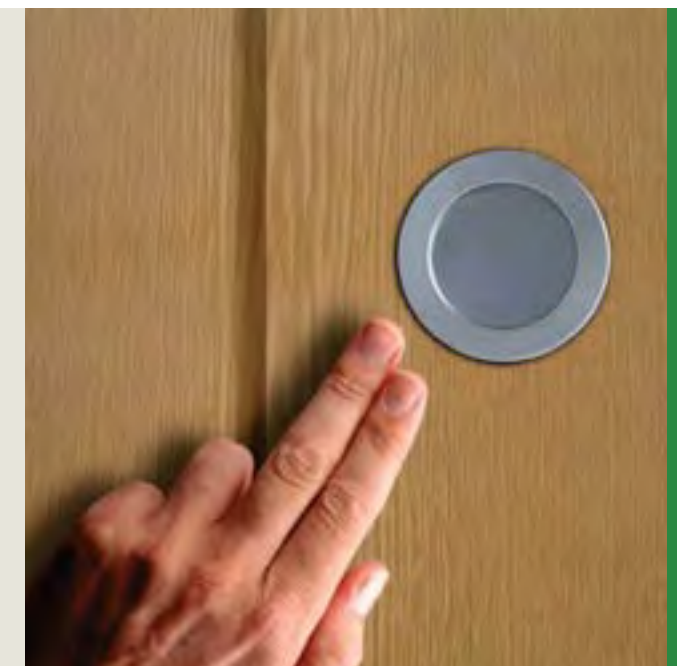

COMPLEMENTOS / COMPLÉMENTS
COMPLÉMENTS / ERGÄNZUNGEN



vista posterior
face arrière
rear face
Rückansicht

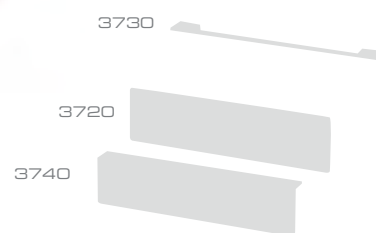

SEIZE



3710



SCENE



	mm	mm	mm	mm	mm
3720	180	160	50	175x45	16
3730	180	170	25	146x19	18
3740	180	160	45	168x40	16

	mm	mm	mm	mm	mm
021					
038					
400					
800					

ZAMAK
METAL
METAL
METALL

021
Aluminio
Aluminium
Aluminium
Aluminium

038
Niquel cepillado
Nickelé brossé
Brushed nickel
Gebürstetes Nickel

400
Cromo brillo
Chromé brillant
Bright chrome
Glänzend verchromt

800
Cromo mate
Chromé mat
Dull chrome
Matt verchromt

ZAMAK
METAL
METAL
METALL

021
Aluminio
Aluminium
Aluminium
Aluminium



	mm	mm	mm	mm
3710	80x80	64	76x76	14

ZAMAK
METAL
METAL
METALL

Inox look

038
Niquel cepillado
Nickelé brossé
Brushed nickel
Gebürstetes Nickel

100
Dorado brillo
Doré brillant
Gold plated
Glänzend vergoldet

400
Cromo brillo
Chromé brillant
Bright chrome
Glänzend verchromt

800
Cromo mate
Chromé mat
Dull chrome
Matt verchromt



3600
3560
3561
3562



3500
3510
3511
3512

ARTTECH
COLLECTION

STYLUS

ARTTECH
COLLECTION

STYLUS

	▶mm◀	∅mm	mm	mm
3600	64x64		60x60	11
3560	50x50		45x45	11
3561	39x39		35x35	11
3562	29x29		26x26	11

ZAMAK
METAL
METAL
METALL

Inox look			
038	100	400	800
Níquel cepillado Nickelé brossé Brushed nickel Gebürstetes Nickel	Dorado brillo Doré brillant Gold plated Glänzend vergoldet	Cromo brillo Chromé brillant Bright chrome Glänzend verchromt	Cromo mate Chromé mat Dull chrome Matt verchromt



	▶mm◀	∅mm	mm	mm
3500		65	60	11
3510		49	45	11
3511		40	35	11
3512		30	26	11

ZAMAK
METAL
METAL
METALL

	Inox look			
002	038	100	400	800
Blanco Blanc White Weiß	Níquel cepillado Nickelé brossé Brushed nickel Gebürstetes Nickel	Dorado brillo Doré brillant Gold plated Glänzend vergoldet	Cromo brillo Chromé brillant Bright chrome Glänzend verchromt	Cromo mate Chromé mat Dull chrome Matt verchromt

COMPLEMENTOS / COMPLÉMENTS
COMPLEMENTS / ERGÄNZUNGEN



3701

3703

3702



3940

ARTTECH

COLLECTION

INLAY



	▶mm◀	▶mm◀	▶mm◀	▶mm◀
3701	145	50	139x40	11
3702	113	42	110x35	11
3703	83	36	78x26	11

ZAMAK
METAL
METAL
METALL



038
Níquel cepillado
Nickelé brossé
Brushed nickel
Gebürstetes Nickel



100
Dorado brillo
Doré brillant
Gold plated
Glänzend vergoldet



400
Cromo brillo
Chromé brillant
Bright chrome
Glänzend verchromt



800
Cromo mate
Chromé mat
Dull chrome
Matt verchromt



	▶mm◀	◊mm◊	▶mm◀	◊mm◊	◊mm◊
3940	130	64	34		

ZAMAK
METAL
METAL
METALL



021
Aluminio
Aluminium
Aluminium
Aluminium



038
Níquel cepillado
Nickelé brossé
Brushed nickel
Gebürstetes Nickel



805
Latón cepillado rústico
Laiton brossé rustique
Rustic brushed brass
Messing rustikal, gebürstet



807
Hierro rústico
Fer rustique
Rustic iron
Eisen rustikal



836
Estaño rústico
Etain rustique
Rustic tin
Zinn rustikal

COMPLEMENTOS / COMPLÉMENTS
COMPLÉMENTS / ERGÄNZUNGEN

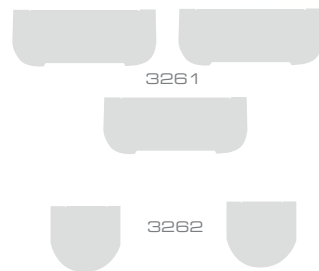



	▶mm◀	⌀mm⌀	▶mm◀	Ømm	↻mm
3261	80	35			
3262	36	36			

- 
002
 Blanco
 Blanc
 White
 Weiß
- 
038
 Niquel cepillado
 Nickelé brossé
 Brushed nickel
 Gebürstetes Nickel
- 
100
 Dorado brillo
 Doré brillant
 Gold plated
 Glänzend vergoldet
- 
500
 Niquel satinado
 Nickelé satiné
 Satin nickel
 Satiniertes Nickel
- 
800
 Cromo mate
 Chromé mat
 Dull chrome
 Matt verchromt



	▶mm◀	⌀mm⌀	▶mm◀	Ømm	↻mm
3251	70	40			
3252	35	35			

- 
112
 Dorado brillo/Pintado dorado
 Doré brillant/Peint en doré
 Gold plated/Gold painted
 Glänzend vergoldet/Golden bemalt
- 
413
 Cromo brillo/Pintado plata
 Chromé brillant/Peint en argenté
 Bright chrome/Silver painted
 Glänzend verchromt/Silbern bemalt

	▶mm◀	⌀mm⌀	▶mm◀	Ømm	↻mm
3271	82	38			
3272	38	50			

- 
100
 Dorado brillo
 Doré brillant
 Gold plated
 Glänzend vergoldet
- 
200
 Dorado satinado
 Doré satiné
 Satin gold plated
 Satiniertes Gold
- 
500
 Niquel satinado
 Nickelé satiné
 Satin nickel
 Satiniertes Nickel

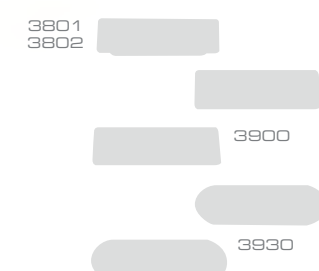
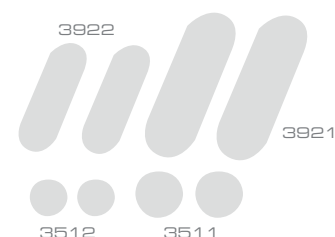

	mm	mm	mm	mm
3511	40	35	11	
3512	30	26	11	

	mm	mm	mm	mm
3921	150	40	103x26	11
3922	110	36	69x26	11

	mm	mm	mm	mm
3801	115	42	93x32	13
3802	80	36	67x27	13

	mm	mm	mm	mm
3900	110	96	40	104x30
3930	110	96	40	88x30

 002 Blanco Blanc White Weiß	 038 Níquel cepillado Nickelé brossé Brushed nickel Gebürstetes Nickel	 100 Dorado brillo Doré brillant Gold plated Glänzend vergoldet
 400 Cromo brillo Chromé brillant Bright chrome Glänzend verchromt	 800 Cromo mate Chromé mat Dull chrome Matt verchromt	

 002 Blanco Blanc White Weiß	 038 Níquel cepillado Nickelé brossé Brushed nickel Gebürstetes Nickel	 100 Dorado brillo Doré brillant Gold plated Glänzend vergoldet
 400 Cromo brillo Chromé brillant Bright chrome Glänzend verchromt	 800 Cromo mate Chromé mat Dull chrome Matt verchromt	 831 Bronce rústico Bronze rustique Antique brass Bronze rustikal

 112 Latón brillo/Pintado dorado Laiton brillant/Peint en doré Bright brass/Gold painted Glänzendes Messing/Golden bemalt	 403 Cromo brillo/Negro Chromé brillant/Noir Bright chrome/Black Glänzend verchromt/Schwarz
 413 Cromo brillo/Pintado plata Chromé brillant/Peint en argenté Bright chrome/Silver painted Glänzend verchromt/Silbern bemalt	

 112 Dorado brillo/Pintado dorado Doré brillant/Peint en doré Gold plated/Gold painted Glänzend vergoldet/Golden bemalt	 413 Cromo brillo/Pintado plata Chromé brillant/Peint en argenté Bright chrome/Silver painted Glänzend verchromt/Silbern bemalt
---	---

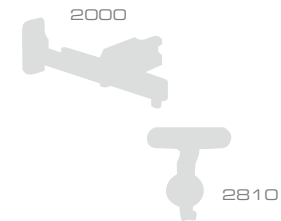

	▶mm◀	▶mm◀	▶mm◀	▶mm◀
3502	52x52	45	8	
3503	44x44	38	7	



3552	52x52	45	8	
------	-------	----	---	--



2000	140			
------	-----	--	--	--

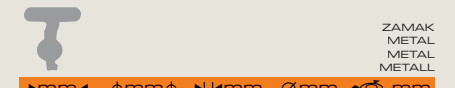

2810	70x70			
------	-------	--	--	--

100	200	400	800	900	002	100	400	500
Dorado brillo Doré brillant Gold plated Glänzend vergoldet	Dorado satinado Doré satiné Satin gold plated Satinierteres gold	Cromo brillo Chromé brillant Bright chrome Glänzend verchromt	Cromo mate Chromé mat Dull chrome Matt verchromt	Bronce viejo Vieux bronze Old bronze Antik bronziert	Blanco Blanc White Weiß	Dorado brillo Doré brillant Gold plated Glänzend vergoldet	Cromo brillo Chromé brillant Bright chrome Glänzend verchromt	Níquel satinado Nickelé satiné Satin nickel Satinierteres Nickel

En blister packs con elementos de fijación incluidos.
 Dans des blisters, tous les éléments de fixation inclus.
 In blisters, all fitting elements included.
 In Blisterverpackung, Befestigungselemente eingeschlossen.



112

Latón brillo/Pintado dorado
Laiton brillant/Peint en doré
Bright brass/Gold painted
Glänzendes Messing/Golden bemalt

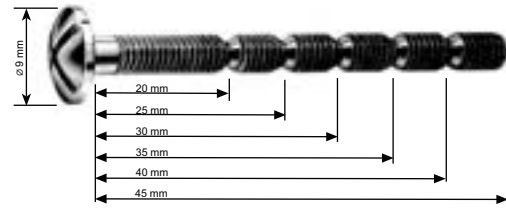

	mm	mm	mm	mm	mm
M-45	20	25	30	35	40
M-45	25	30	35	40	45
M-45	30	35	40	45	
M-45	35	40	45		
M-45	40	45			
M-45	45				

HIERRO
FER
IRON
EISEN

TORNILLO MULTILARGO / Hierro

M-45 Bichromatado
VIS MULTILONGUEUR / Fer
M-45 Bichromaté
MULTISIZE SCREW / Iron
M-45 Zinc-yellow
MULTILÄNGEN SCHRAUBE / Eisen
M-45 Bichromatiert

TORNILLO MULTILARGO DE CORTE LIMPIO QUE SIEMPRE ROSCA

REDUZCA LA INVERSIÓN
En inmovilizado y el riesgo de restos invendibles sustituyendo los tornillos de diversas longitudes por el tornillo multilargo ESTAMP.

VIS MULTILONGUEUR QUI SE COUPE FACILEMENT SANS ABÎMER LE FILETAGE

REDUISEZ L'INVESTISSEMENT
Des stocks immobilisés et le risque d'invendus en remplaçant les vis de différentes longueurs par une seule vis multilongueur ESTAMP.

MULTISIZE SCREW NET CUT THAT ALWAYS CUTS

REDUCE INVESTMENT
In stocks and risk of not saleable rests substituting screws of different lengths for multisize ESTAMP screw.

MULTILÄNGENSCHRAUBE IMMER GÄNGIG DANK DEM SAUBEREN GEWINDESCHNITT

REDUZIEREN SIE IHRE INVESTITIONEN
In Anlagen und vermeiden Sie das Risiko, auf unverkäuflichen Resten sitzen zu bleiben. Verwenden Sie anstatt Schrauben verschiedener Längen die ESTAMP Multilängen-schraube.

REDUZCA EL ESPACIO
De almacenaje manteniendo en stock una sola longitud de tornillo.

REDUISEZ LE VOLUME
De stockage en disposant d'une seule longueur de vis.

REDUCE SPACE
For storage keeping only one length of screw.

GERINGERER LAGERPLATZBEDARF
Dank einer einzigen Schrauben-länge.

REDUZCA EL GASTO
En mano de obra eliminando el limado de espárragos tradicionales al utilizar el tornillo multilargo ESTAMP de corte limpio y roscado directo.

REDUISEZ LES FRAIS
De main-d'oeuvre pour le limage des tiges traditionnelles en utilisant la vis ESTAMP multilongueur de coupe facile et directe vis.

REDUCE EXPENSES
On labour eliminating filing of traditional screw by using multisize ESTAMP screws of net cut and direct screw.

REDUZIEREN SIE IHRE LOHNCOSTEN
Die sauber geschnittene, direktgängige ESTAMP Multilängenschraube macht das herkömmliche Steh-schraubenfeilen überflüssig.

ADAPTABLE
A los gruesos de madera utilizados en carpintería y ebanistería. Nuestros herrajes ESTAMP llevan incorporados este nuevo tipo de tornillo.

ADAPTABLE
À toutes les épaisseurs de bois utilisés en menuiserie et en ébénisterie. Nos articles ESTAMP portent tous ce nouveau type de vis.

ADAPTABLE
To different thicknesses of wood used in carpentry and woodwork industry. Our fittings ESTAMP are fitted with this new kind of screw.

ANPASSUNGSFÄHIG
Für alle in der Tischlerei und Schreinerei gebräuchlichen Holz-dicken geeignet. Unsere ESTAMP Möbelbeschläge werden mit diesem neuartigen Schraubentyp geliefert.



NYLON
NYLON
NYLON
NYLON

CIERRES A PRESIÓN / Nylon

231 Para puertas grandes
232 Para puertas pequeñas
FERMATURES À PRESSION / Nylon
231 Pour grandes portes
232 Pour petites portes
PRESSURE LOCKS / Nylon
231 For large doors
232 For small doors
DRUCKVERSCHLÜSSE / Nylon
231 Für grosse Türen
232 Für kleine Türen

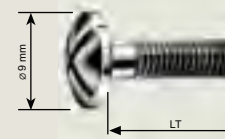

	mm	mm	mm	mm	mm
T-14	14	19	24	29	34
T-21	21	26	31	36	41
T-25	25	30	35	40	45
T-31	31	36	41	46	51
T-35	35	40	45	50	55
T-40	40	45	50	55	60
T-60	60	65	70	75	80

HIERRO
FER
IRON
EISEN

TORNILLOS / Hierro

T Bichromatado
T Bichromaté

SCREWS / Iron

T Zinc-yellow
SCHRAUBE / Eisen
T Bichromatiert

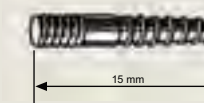

ED-15	15
-------	----

HIERRO
FER
IRON
EISEN

ESPÁRRAGO ROSCA MADERA / Hierro

ED-15 Bichromatado
TIGES FILETÉES POUR BOIS / Fer
ED-15 Bichromaté
WOOD SCREW / Iron
ED-15 Zinc-yellow
GEWINDESCHRAUBE FÜR HOLZ / Eisen
ED-15 Bichromatiert

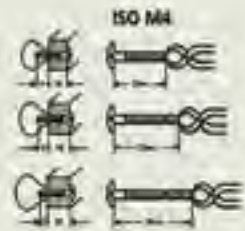

INDICE / INDEX

Pag. / Ref. / Materia prima - Matière Première - Raw Material - Rohmaterial

135 1000	Acero Inoxidable / Acier Inox / Stainless Steel / Rostfreier Stahl	134 1021	Acero Inoxidable / Acier Inox / Stainless Steel / Rostfreier Stahl	132 1107	Acero Inoxidable / Acier Inox / Stainless Steel / Rostfreier Stahl
135 1001	Acero Inoxidable / Acier Inox / Stainless Steel / Rostfreier Stahl	134 1022	Acero Inoxidable / Acier Inox / Stainless Steel / Rostfreier Stahl	132 1108	Acero Inoxidable / Acier Inox / Stainless Steel / Rostfreier Stahl
135 1002	Acero Inoxidable / Acier Inox / Stainless Steel / Rostfreier Stahl	134 1023	Acero Inoxidable / Acier Inox / Stainless Steel / Rostfreier Stahl	132 1109	Acero Inoxidable / Acier Inox / Stainless Steel / Rostfreier Stahl
135 1003	Acero Inoxidable / Acier Inox / Stainless Steel / Rostfreier Stahl	134 1024	Acero Inoxidable / Acier Inox / Stainless Steel / Rostfreier Stahl	137 2101	Acero Inoxidable / Acier Inox / Stainless Steel / Rostfreier Stahl
135 1004	Acero Inoxidable / Acier Inox / Stainless Steel / Rostfreier Stahl	134 1025	Acero Inoxidable / Acier Inox / Stainless Steel / Rostfreier Stahl	137 2102	Acero Inoxidable / Acier Inox / Stainless Steel / Rostfreier Stahl
135 1005	Acero Inoxidable / Acier Inox / Stainless Steel / Rostfreier Stahl	134 1026	Acero Inoxidable / Acier Inox / Stainless Steel / Rostfreier Stahl	136 2111	Zamak / Metal / Metal / Metall
135 1006	Acero Inoxidable / Acier Inox / Stainless Steel / Rostfreier Stahl	134 1027	Acero Inoxidable / Acier Inox / Stainless Steel / Rostfreier Stahl	136 2112	Zamak / Metal / Metal / Metall
135 1007	Acero Inoxidable / Acier Inox / Stainless Steel / Rostfreier Stahl	134 1028	Acero Inoxidable / Acier Inox / Stainless Steel / Rostfreier Stahl	137 2201	Acero Inoxidable / Acier Inox / Stainless Steel / Rostfreier Stahl
135 1008	Acero Inoxidable / Acier Inox / Stainless Steel / Rostfreier Stahl	134 1029	Acero Inoxidable / Acier Inox / Stainless Steel / Rostfreier Stahl	137 2202	Acero Inoxidable / Acier Inox / Stainless Steel / Rostfreier Stahl
135 1009	Acero Inoxidable / Acier Inox / Stainless Steel / Rostfreier Stahl	134 1030	Acero Inoxidable / Acier Inox / Stainless Steel / Rostfreier Stahl	136 2211	Zamak / Metal / Metal / Metall
134 102A	Acero Inoxidable / Acier Inox / Stainless Steel / Rostfreier Stahl	134 1030	Acero Inoxidable / Acier Inox / Stainless Steel / Rostfreier Stahl	136 2212	Zamak / Metal / Metal / Metall
134 102B	Acero Inoxidable / Acier Inox / Stainless Steel / Rostfreier Stahl	132 1101	Acero Inoxidable / Acier Inox / Stainless Steel / Rostfreier Stahl	140 2840	Zamak / Metal / Metal / Metall
134 102C	Acero Inoxidable / Acier Inox / Stainless Steel / Rostfreier Stahl	132 1102	Acero Inoxidable / Acier Inox / Stainless Steel / Rostfreier Stahl	140 2850	Zamak / Metal / Metal / Metall
134 102D	Acero Inoxidable / Acier Inox / Stainless Steel / Rostfreier Stahl	132 1103	Acero Inoxidable / Acier Inox / Stainless Steel / Rostfreier Stahl	140 2860	Zamak / Metal / Metal / Metall
134 102E	Acero Inoxidable / Acier Inox / Stainless Steel / Rostfreier Stahl	132 1104	Acero Inoxidable / Acier Inox / Stainless Steel / Rostfreier Stahl	130 2870	Zamak / Metal / Metal / Metall
134 1020	Acero Inoxidable / Acier Inox / Stainless Steel / Rostfreier Stahl	132 1105	Acero Inoxidable / Acier Inox / Stainless Steel / Rostfreier Stahl	138 7511	Acero Inoxidable / Acier Inox / Stainless Steel / Rostfreier Stahl
		132 1106	Acero Inoxidable / Acier Inox / Stainless Steel / Rostfreier Stahl	138 7512	Acero Inoxidable / Acier Inox / Stainless Steel / Rostfreier Stahl
				138 7513	Acero Inoxidable / Acier Inox / Stainless Steel / Rostfreier Stahl





2870

NEW JAWS



	▶mm◀	φmmφ	▶mm	Ømm	✂mm
2870	104	24	69		59.2

ZAMAK
METAL
METAL
METALL

Inox look

038
Niquel cepillado
Nickelè brossé
Brushed nickel
Gebürstetes Nickel

800

Cromo mate
Chromè mat
Dull chrome
Matt verchromt



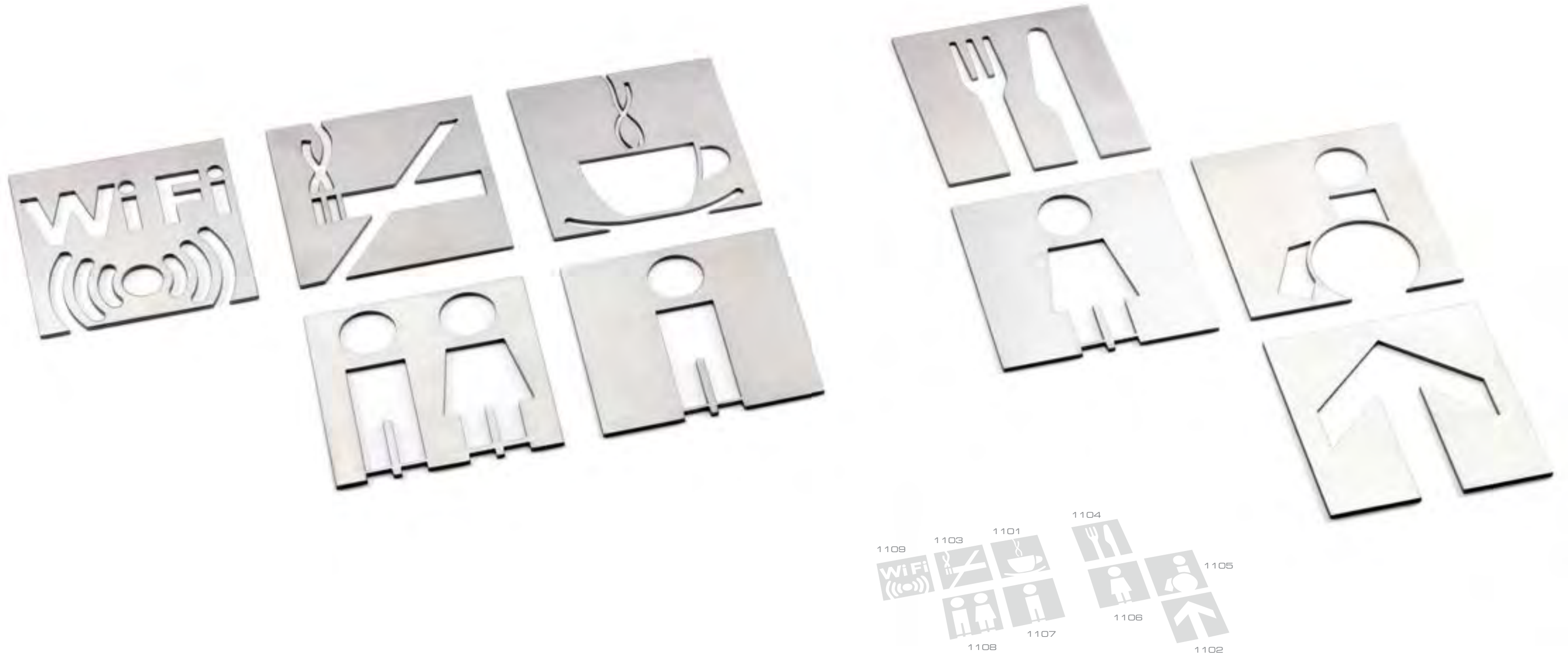

ICONS



ACERO INOXIDABLE
ACIER INOX
STAINLESS STEEL
ROSTFREIER STAHL

	▶mm◀	φmmφ	▶mm	Ømm	✂mm
1101	100	100	2		
1102	100	100	2		
1103	100	100	2		
1104	100	100	2		
1105	100	100	2		
1106	100	100	2		
1107	100	100	2		
1108	100	100	2		
1109	100	100	2		

031

Acero inoxidable cepillado
Acier inox brossé
Brushed stainless steel
Rostfreier Stahl, gebürstet

Instalación con cinta adhesiva de doble cara incluida en el blister.
Installation avec ruban adhésif double-face inclu dans le blister.
Installation with double sided adhesive tape included in blister.
Montage mittels doppelseitigem Klebeband, im Blister enthalten.



En blister packs con elementos de fijación incluidos.
Dans des blisters, tous les éléments de fixation inclus.
In blisters, all fitting elements included.
In Blisterverpackung, Befestigungselemente eingeschlossen.

Montaje para números de 125mm
Montage pour numéros de 125mm
Set up for numbers 125mm
Befestigungsanleitung von Ziffern in 125mm



ICONS



	mm	mm	mm	mm
1020	75	2		
1021	75	2		
1022	75	2		
1023	75	2		
1024	75	2		
1025	75	2		
1026	75	2		
1027	75	2		
1028	75	2		
1029	75	2		
1030	75	2		
102A	75	2		
102B	75	2		
102C	75	2		
102D	75	2		
102E	75	2		

ACERO INOXIDABLE
ACIER INOX
STAINLESS STEEL
ROSTFREIER STAHL

Instalación con cinta adhesiva de doble cara incluida en el blister.
Installation avec ruban adhésif double-face inclus dans le blister.
Installation with double sided adhesive tape included in blister.
Montage mittels doppelseitigem Klebeband, im Blister enthalten.



	mm	mm	mm	mm
1000	125	2		
1001	125	2		
1002	125	2		
1003	125	2		
1004	125	2		
1005	125	2		
1006	125	2		
1007	125	2		
1008	125	2		
1009	125	2		

031
Acero inoxidable cepillado
Acier inox brossé
Brushed stainless steel
Rostfreier Stahl, gebürstet





GRIP / GRIP DUO / BAR / BAR DUO



GRIP / GRIP DUO		ZAMAK METAL METAL METALL			
		mm	mm	mm	mm
2111	317	300	25	52	
2112	217	200	25	48	
2211	317	300	25	52	
2212	217	200	25	48	

Inox look
038
Niquel cepillado
Nickelé brossé
Brushed nickel
Gebürstetes Nickel

400
Cromo brillo
Chromé brillant
Bright chrome
Glänzend verchromt

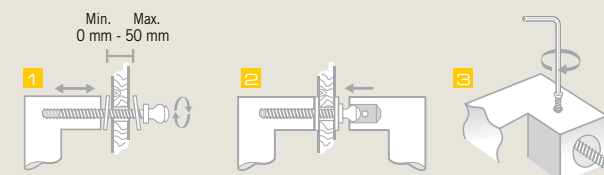

BAR / BAR DUO		ACERO INOXIDABLE ACIER INOX STAINLESS STEEL ROSTFREIER STAHL			
		mm	mm	mm	mm
2101	315	300	25	65	
2102	215	200	25	65	
2201	315	300	25	65	
2202	215	200	25	65	

031
Acero inoxidable cepillado
Acier inox brossé
Brushed stainless steel
Rostfreier Stahl, gebürstet

DECORCLASS

COMPLEMENT S

Tiradores de trazo puro, terminación impecable y gran carácter. El complemento perfecto para sus puertas de madera o cristal.

Poignées aux traits purs, finition impeccable et grand caractère. Le complément parfait pour vos portes en bois ou en cristal.

Handles with pure lines, perfect finish and strong character. The perfect complement for your wooden and crystal doors.

Griffe mit klaren Linien, tadellosem Finish und starkem Charakter. Die perfekte Ergänzung für Ihre Türen aus Glas oder Holz.

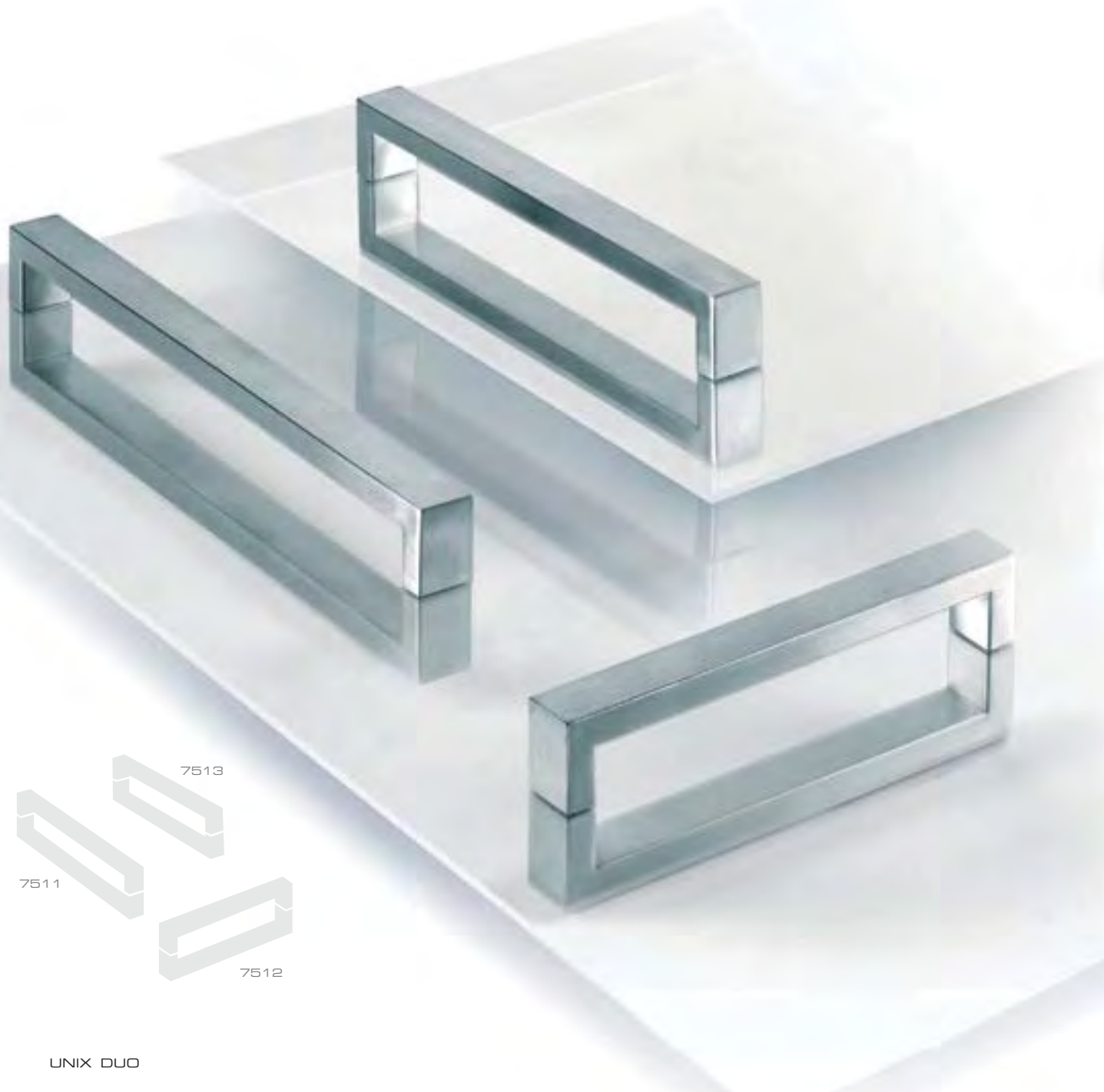

UNIX DUO

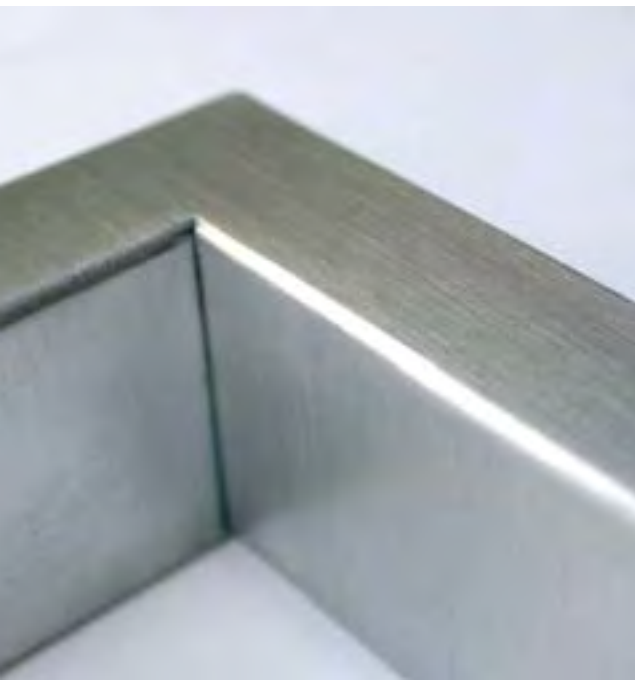

ACERO INOXIDABLE
ACIER INOX
STAINLESS STEEL
ROSTFREIER STAHL

	▶mm◀	φmmφ	▶mm	Ømm	◀mm
7511	333	320	25	38	
7512	269	256	25	38	
7513	205	192	25	38	

Elementos de fijación incluidos.
Éléments de fixation inclus.
All fitting elements included.
Befestigungselemente eingeschlossen.



031
Acero inoxidable cepillado
Acier inox brossé
Brushed stainless steel
Rostfreier Stahl, gebürstet

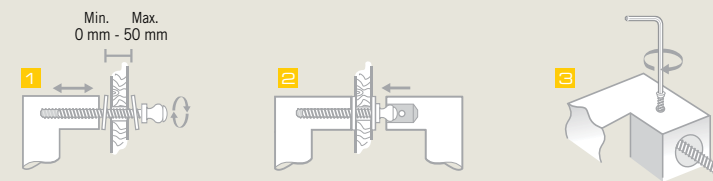



SLIDE



La mayor calidad al servicio del diseño más innovador.
La meilleure qualité au service du design le plus innovateur.
Best quality for the most innovative design.
Beste Qualität für das neuartigste Design.



ZAMAK
METAL
METAL
METALL



2840	54x44
2850	55x49
2860	56x25

Inox look

038

Níquel cepillado
Nickelé brossé
Brushed nickel
Gebürstetes Nickel

400

Cromo brillo
Chromé brillant
Bright chrome
Glänzend verchromt

800

Cromo mate
Chromé mat
Dull chrome
Matt verchromt



Los colgadores individuales poseen una efectiva y fácil manera de fijación.

Les portemanteaux individuels incorporent un système de fixation simple et efficace.

Individual hangers grant an easy and effective fixing system.

Die Einzelkleiderhaken verfügen über ein einfaches und wirksames Befestigungssystem.

Ref.	Pag.	Ref.	Pag.	Ref.	Pag.	Ref.	Pag.	Ref.	Pag.	Ref.	Pag.
231	127	3710	115	6771	12	7502	70	8152	13	9771	97
232	127	3720	114	6772	12	7503	70	8161	13	9772	97
1000	135	3730	114	6781	10	7504	70	8162	13	9821	96
1001	135	3740	114	6782	10	7505	70	8171	13	9822	96
1002	135	3750	111	6791	11	7506	70	8172	13	9831	96
1003	135	3801	123	6792	11	7511	138	8191	65	9832	96
1004	135	3802	123	7000	72	7512	138	8192	65	9841	96
1005	135	3900	123	7001	72	7513	138	8321	49	9842	96
1006	135	3921	122	7002	72	7520	24	8322	49	9851	96
1007	135	3922	122	7003	72	7521	24	8323	49	9852	96
1008	135	3930	123	7004	72	7531	18	8324	49	9912	106
1009	135	3940	119	7005	72	7532	18	8351	49	9913	106
102A	134	5001	87	7006	72	7541	26	8352	49	9932	105
102B	134	5002	87	7007	72	7542	26	8353	49	9933	105
102C	134	5101	86	7008	72	7543	26	8354	49	9952	105
102D	134	5102	86	7009	72	7552	46	8361	77	9953	105
102E	134	5201	87	7010	73	7553	46	8362	77	9982	107
1020	134	5202	87	7011	73	7554	46	8363	77	9983	107
1021	134	5221	87	7012	73	7561	63	8461	53	9991	104
1022	134	5222	87	7013	73	7562	63	8462	53	9992	104
1023	134	5601	83	7014	73	7570	19	8463	53	9993	104
1024	134	5602	83	7015	73	7571	19	8471	52	ED-15	127
1025	134	5603	83	7016	73	7572	19	8472	52	M-45	126
1026	134	5604	83	7017	73	7581	62	8473	52	T-14	127
1027	134	5605	83	7018	73	7582	62	8491	66	T-21	127
1028	134	5606	83	7019	73	7590	16	8521	56	T-25	127
1029	134	5607	83	7020	24	7610	76	8561	63	T-31	127
1030	134	5608	83	7021	24	7611	76	8562	63	T-35	127
1101	132	5611	85	7022	24	7612	76	8581	62	T-40	127
1102	132	5612	85	7023	24	7613	76	8651	52	T-60	127
1103	132	5613	85	7024	24	7614	76	8652	52		
1104	132	5614	85	7025	24	7651	21	8653	52		
1105	132	5615	84	7026	24	7652	21	8661	53		
1106	132	5616	84	7031	32	7653	21	8662	53		
1107	132	5617	84	7032	32	7661	23	8671	43		
1108	132	5618	84	7051	43	7662	23	8672	43		
1109	132	5619	84	7052	43	7663	23	8673	43		
2000	125	5621	85	7061	44	7681	20	8701	40		
2101	137	5622	85	7062	44	7682	20	8702	40		
2102	137	5623	85	7081	42	7683	20	8711	40		
2111	136	5624	84	7082	42	7684	20	8712	40		
2112	136	5625	84	7121	41	7691	22	8721	45		
2201	137	5626	85	7122	41	7692	22	8722	45		
2202	137	5627	84	7131	38	7693	22	8731	41		
2211	136	5628	84	7132	38	7694	22	8732	41		
2212	136	5629	84	7140	38	7751	17	8780	33		
2810	125	5981	81	7150	39	7810	76	8790	50		
2840	140	5982	81	7191	64	7811	76	8800	35		
2850	140	5983	81	7192	64	7812	76	8810	48		
2860	140	6130	57	7241	30	7813	76	8820	48		
2870	130	6131	57	7242	30	7814	76	8830	48		
3251	121	6132	57	7251	33	7830	51	8841	55		
3252	121	6141	61	7252	33	7861	47,77	8842	55		
3261	120	6142	61	7281	37	7862	47,77	8851	31		
3262	120	6150	59	7282	37	7891	75	8852	31		
3271	121	6151	59	7291	36	7892	75	8871	54		
3272	121	6152	59	7292	36	7921	74	8921	74		
3281	112	6160	60	7321	35	7922	74	8922	74		
3282	112	6161	60	7322	35	7923	74	9062	93		
3500	117	6162	60	7371	55	7930	42	9063	93		
3502	124	6170	58	7372	55	7950	71	9090	91		
3503	124	6171	58	7381	31	7951	71	9381	90		
3510	117	6180	14	7382	31	7952	71	9382	90		
3511	117,122	6181	14	7411	34	7953	71	9383	90		
3512	117,122	6182	14	7412	34	7954	71	9390	92		
3530	113	6183	14	7421	54	7971	75	9391	92		
3531	113	6184	14	7422	54	7972	75	9501	101		
3532	113	6185	14	7461	25	7991	45	9502	101		
3533	113	6186	14	7462	25	7992	45	9531	100		
3541	110	6187	14	7463	25	8010	50	9532	100		
3542	110	6521	56	7471	29	8080	25	9533	100		
3552	124	6751	17	7472	29	8090	29	9551	101		
3560	116	6752	17	7473	29	8101	27	9552	101		
3561	116	6761	15	7481	28	8102	27	9651	99		
3562	116	6762	15	7482	28	8103	27	9652	99		
3600	116	6763	15	7483	28	8130	26	9681	99		
3701	118	6764	15	7491	67	8141	61	9682	99		
3702	118	6765	15	7492	67	8142	61	9700	98		
3703	118	6770	12	7501	70	8151	13	9770	97		

En constante avance y mejora de sus productos, J.José Vergés S.A. se reserva el derecho a modificar los diseños de sus modelos.

J.José Vergés S.A. se reserva el derecho a modificar las fotos, planos, dibujos y descripciones de los artículos que figuran en el presente catálogo.

Los datos técnicos que figuran en este catálogo admiten una tolerancia en las medidas de $\pm 1.0\text{mm}$.

La empresa podrá discontinuar la producción de los productos incluidos en este catálogo previa notificación de 6 meses.

Agradecemos la confianza depositada por nuestros clientes que nos incentiva a seguir trabajando con la máxima calidad, para ofrecer un producto y servicio óptimo.

Todos los derechos reservados.

En constant développement et soucis d'amélioration de leurs produits, J. José Vergés S.A. se réserve le droit de modifier les designs de leurs modèles.

J. José Vergés S.A. se réserve le droit de modifier les photos, plans, dessins techniques et descriptions des articles qui figurent dans le présent catalogue.

Les données techniques qui figurent dans ce catalogue permettent une tolérance dans les mesures de $\pm 1.0\text{mm}$.

La Société pourra arrêter la production des produits inclus dans le présent catalogue avec un préavis de 6 mois.

Nous apprécions la confiance en nous qu'ont nos clients, ce qui nous encourage de continuer à travailler, offrant ainsi la meilleure qualité possible, pour nos produits avec service optimal.

Tous les droits réservés.

In constant development and improvement of their products, J. José Vergés S.A. reserves the right to change the design of their models.

J. José Vergés S.A. reserves the right to modify photos, plans, drawings and descriptions of the items listed in this catalogue.

The technical data contained in this catalogue admits a tolerance in measurements of $\pm 1.0\text{mm}$.

The company may discontinue the production of the items listed in this catalogue, subject to prior notice of 6 months.

We appreciate the trust placed in us by our customers, which encourages us to continue working with the highest quality to supply optimal products and services.

All rights reserved.

Stetiger Fortschritt und Produktverbesserung. J.José Vergés SA behält sich das Recht auf Änderung des Designs seiner Modelle vor.

J.José Vergés SA behält sich das Recht vor, Fotos, Pläne, Zeichnungen und Beschreibungen der Produkte in diesem Katalog zu ändern.

Die in diesem Katalog enthaltenen technischen Daten haben eine Toleranz von $\pm 1,0\text{ mm}$.

Die Firma kann die Produktion der dargestellten Produkte unter einer Benachrichtigungsfrist von 6 Monaten einstellen.

Wir schätzen das Vertrauen unserer Kunden. Es ermutigt uns, weiterhin mit einem Produkt höchster Qualität zu arbeiten und einen optimalen Service anzubieten.

Alle Rechte vorbehalten.

