

Cinco

Programa Aluminio **Cinco**

Zócalo - PVC Laminado Aluminio Cepillado _____	341
Zócalo Espejo <i>Zoccoli Specchio</i> _____	342
Zócalo - PVC Laminado Espejo _____	344
Zócalo - PVC Laminado Blanco - Zócalo Aluminio - Perfil PVC protector zócalo madera _____	345
Alzatina <i>Detalles Creativos</i> _____	346
Copete - D9 _____	348
Copete - D7 _____	349
Copete - D8 _____	350
Copete - D2 - D3 _____	351
Gola Abierta <i>Un clásico en la actualidad</i> _____	352
Gola Abierta - Horizontal Encimera _____	355
Gola Abierta - Horizontal Cajón _____	357
Gola Abierta - Horizontal Superior (mueble alto) _____	359
Gola Abierta - Vertical Lateral - Vertical Media _____	361
Gola Cerrada <i>Una mirada al futuro</i> _____	362
Gola Cerrada - Horizontal Encimera _____	364
Gola Cerrada - Horizontal Cajón _____	365
Perfil Beta <i>Una alternativa acertada</i> _____	366
Perfil Uñero - Beta - Gamma _____	368
Perfil Uñero - Alpha _____	369
Vitrinas <i>Nuevos Conceptos Estéticos</i> _____	370
Vitrinas de Aluminio - Ada _____	372
Vitrinas de Aluminio - Lar _____	373
Vitrinas de Aluminio - Básica _____	374
Vitrinas de Aluminio - Básica Inox _____	375
Vitrinas de Aluminio - Pel _____	376
Vitrinas de Aluminio - Mega _____	377
TIR <i>1,2,3 ¡Acción!</i> _____	378
Vitrinas de Aluminio - Tir _____	381

Programa Aluminio **Cinco**

Vitrinas de Aluminio - Tarifas Modelos Ada - Lar - Básica - Básica Inox - Pel - Mega _____	382
Vitrinas de Aluminio - Tarifas Modelos Tir - Tir Chocolate - Tir Negro - Tir Blanco _____	383
Perfiles - Perfil Vitrina Alba - Perfil PVC Interior Vitrina _____	384
Accesorios - Accesorios de Encimera _____	385
Protectores - Protector Costado - Protector Lateral Horno - Protector Encimera _____	387
Aireación <i>Múltiples Soluciones</i> _____	388
Protectores - Lateral de Campana - Marco Microondas Universal _____	390
Rejillas - Rejilla Aireación Aluminio _____	391
Rejillas - Rejilla Aireación Acero Inox _____	391
Rejillas - Rejilla Aireación Tabica Horno _____	391
Rejillas - Rejilla Aireación Inducción _____	391
Rejillas - Rejilla Aireación Zócalo _____	391
Base ABS Kautät <i>Alta gama, pequeños detalles</i> _____	392
Protector Fregadero - Base ABS Perfil Antihumedad - Base Rombotino Perfil Antihumedad_	393
Perfil Refuerzo - Supra Delantero - Supra Trasero _____	394
Perfil Refuerzo - Deluxe - Concept _____	395
Perfil Aluminio - Perfil Unión Puertas _____	396



Zócalo ■ Copete ■ Gola Vertical ■ Perfiles ■ ABS ■ Inox ■ Vitrinas



Zócalo

PVC Laminado Aluminio Cepillado



Ángulo Variable
Pernio



Ángulo Variable



Tapa Rincón/Esquina



Multiángulo



Zócalo PVC aluminio Cepillado



Tapa

i Abrazadera recomendada 226 cod.0615107.
(Ver pág. 428.)

Sus beneficios

- » Acabado aluminio cepillado e inox.
- » Soporte para sujeción pinza en medio punto, lo cual hace mas resistente el zócalo a la flexión.
- » Goma coextruida para un perfecto ajuste y estanqueidad al suelo.
- » Ángulo variable para cepillado horizontal (único en el mercado).
- » PVC virgen. Normativa CE.

Código	Descripción	Longitud	Alto	Acabado	Embalaje
0520587	Zócalo	4 ml.	80	Aluminio Cepillado	17
0892287	Zócalo	4 ml.	100	Aluminio Cepillado	15
0892387	Zócalo	4 ml.	120	Aluminio Cepillado	15
0871787	Zócalo	4 ml.	150	Aluminio Cepillado	15
0892487	Zócalo	4 ml.	180	Aluminio Cepillado	12
0500391	Zócalo	4 ml.	100	Ínox	15
0500491	Zócalo	4 ml.	150	Ínox	15
0891687	Ángulo Variable	---	100	Aluminio Cepillado	250
0500497	Ángulo Variable	---	120	Aluminio Cepillado	100
0872887	Ángulo Variable	---	150	Aluminio Cepillado	200
0891787	Ángulo Variable	---	180	Aluminio Cepillado	150
0599287	Ángulo Variable Pernio	---	100	Aluminio Cepillado	224
0599387	Ángulo Variable Pernio	---	120	Aluminio Cepillado	168
0599487	Ángulo Variable Pernio	---	150	Aluminio Cepillado	140
0599587	Ángulo Variable Pernio	---	180	Aluminio Cepillado	140
0501691	Ángulo Variable Pernio	---	100	Ínox	224
0501791	Ángulo Variable Pernio	---	150	Ínox	140
0891887	Multiángulo	---	100	Aluminio Cepillado	156
0500587	Multiángulo	---	120	Aluminio Cepillado	132
0891987	Multiángulo	---	150	Aluminio Cepillado	104
0892087	Multiángulo	---	180	Aluminio Cepillado	88
0501291	Multiángulo	---	100	Ínox	156
0500591	Multiángulo	---	150	Ínox	104
0872587	Tapa Rincón / Esquina	---	100	Aluminio Cepillado	156
0500687	Tapa Rincón / Esquina	---	120	Aluminio Cepillado	132
0872487	Tapa Rincón / Esquina	---	150	Aluminio Cepillado	104
0892187	Tapa Rincón / Esquina	---	180	Aluminio Cepillado	88
0501391	Tapa Rincón / Esquina	---	100	Ínox	156
0500691	Tapa Rincón / Esquina	---	150	Ínox	104
0892020	Tapa	---	150	Gris	250



Zócalo Espejo

Zoccoli Specchio



Zócalo PVC Espejo



Tapa Rincón/Esquina

Código	Descripción	Longitud	Alto	Acabado	Embalaje
0500291	Zócalo	4 ml.	150	Espejo	15 
0500191	Tapa Rincón / Esquina	---	150	Espejo	100

i Abrazadera recomendada 226 cod. 0615107 (Ver pág. 428).



Zócalo

PVC Laminado Blanco



Tapa



Ángulo Variable Pernio



Multiángulo



Tapa Rincón/Esquina



Zócalo PVC Blanco

i Abrazadera recomendada 226 cod. 0615107 (Ver pág 428).

Código	Descripción	Longitud	Alto	Acabado	Embalaje
0561001	Zócalo	4 ml.	100	Blanco	15
0890401	Zócalo	4 ml.	150	Blanco	15
0561101	Ángulo Variable Pernio	---	100	Blanco	224
0561201	Ángulo Variable Pernio	---	150	Blanco	112
0891001	Multiángulo	---	150	Blanco	104
0890801	Tapa Rincón/Esquina	---	150	Blanco	104
0890301	Tapa	---	150	Blanco	250

Zócalo Aluminio

KAUTÄT



Ángulo Variable



Zócalo

i Abrazadera recomendada n93 cod. 0602207 (Ver pág. 428).

Código	Descripción	Longitud	Alto	Acabado	Embalaje
0805687	Zócalo	4 ml.	144	Plata	10
0829687	Ángulo Variable	---	144	Plata/Gris	200

Perfil PVC Protector Zócalo Madera

KAUTÄT

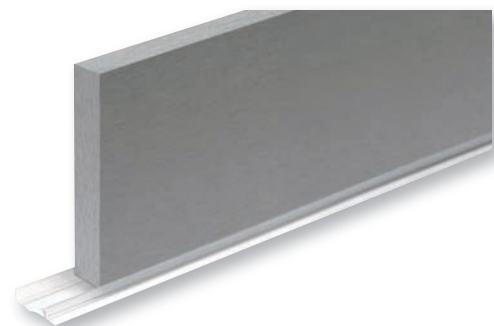
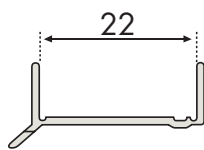
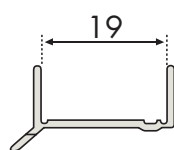
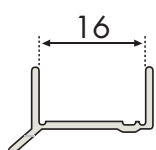

Código	Descripción	Longitud	Ancho	Acabado	Embalaje
0870550	Perfil Zócalo	3,60 ml.	16 mm.	Transparente	100
0870650	Perfil Zócalo	3,60 ml.	19 mm.	Transparente	100
0500250	Perfil Zócalo	3,60 ml.	22 mm.	Transparente	90





Alzatina

“Detalles Creativos”

Sus beneficios

- » Sistema de clip que facilita su montaje.
- » Goma de ajuste a encimera semioculta, que mejora la estética.
- » Cepillado a juego con el zócalo PVC aluminio.
- » Kit accesorios aluminio.

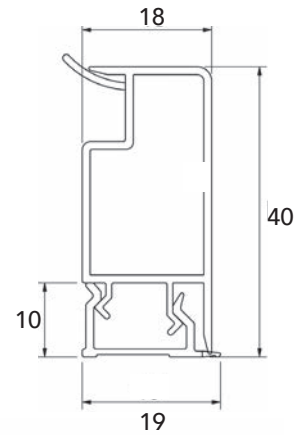

Kit Rincón + Tapas



Kit Esquina + Tapas

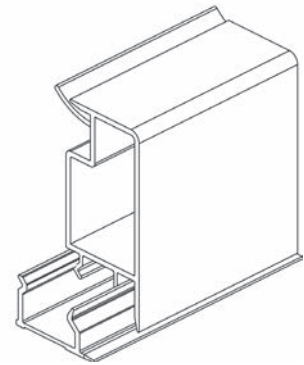

Código	Descripción	Longitud	Acabado	Embalaje
0520687	Copete PVC	4 ml.	Aluminio Cepillado	15
0520787	Kit Rincón+Tapas	---	Aluminio	100
0520887	Kit Esquina+Tapas	---	Aluminio	100



Copete

D7

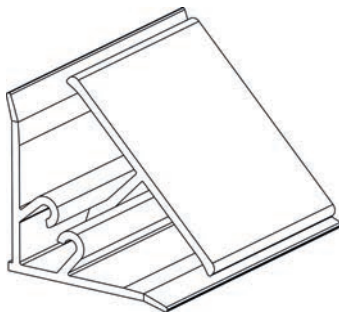
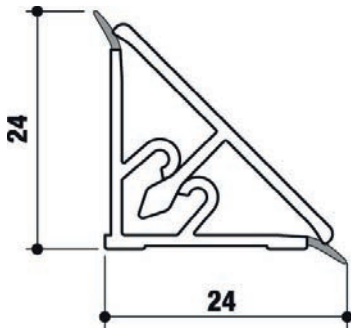

Kit Accesorios

Sus beneficios

- » Más discreto que los copetes tradicionales.
- » Kit accesorios en PVC gris que no tiene patillas de montaje, mayor fijación y resistencia al uso.
- » En este modelo, el corte del plástico y del aluminio son de la misma medida.
- » Copete acabado aluminio e inox.

Código	Descripción	Longitud	Acabado	Embalaje
0890187	Copete Aluminio	4 ml.	Aluminio	30
0500791	Copete Aluminio	4 ml.	Ínox	30
0890220	Kit Accesorios	---	Gris	150
0500891	Kit Accesorios	---	Ínox	150

i Kit Accesorios compuesto por: 1 Rincón, 1 Esquina y 1 Juego de Tapas

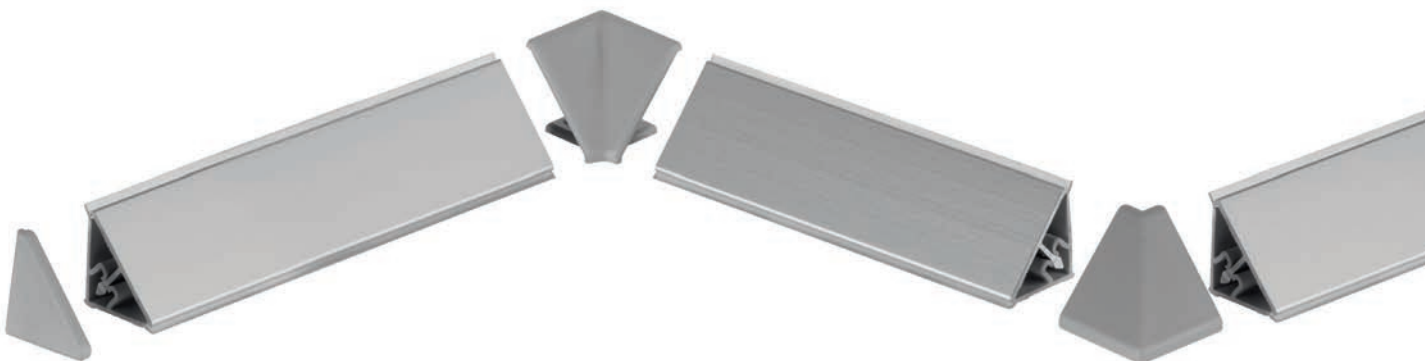

Sus beneficios

- » Copete cóncavo con laminado en aluminio cepillado. Ideal para combinarlo con el zócalo del mismo acabado.
- » En este modelo, el corte del plástico y del aluminio son de la misma medida.
- » Kit de accesorios en PVC blanco o gris, sin patillas de montaje, mayor fijación y resistencia al uso.

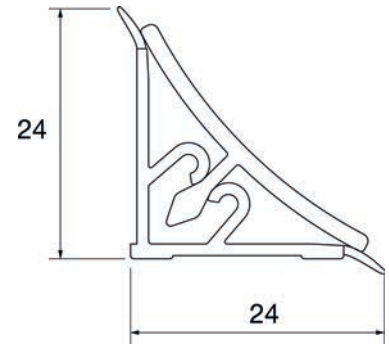
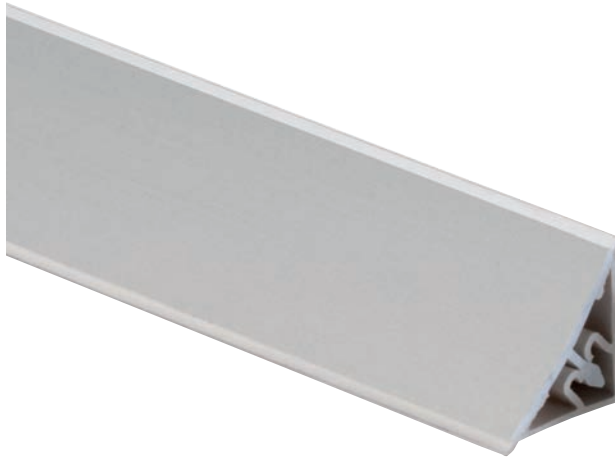

Kit Accesorios

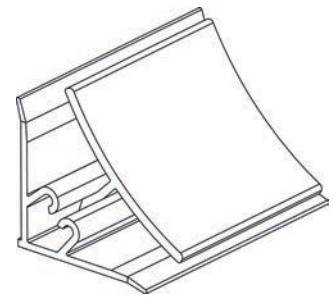

Código

0890287

Descripción

Copete PVC

Longitud

4 ml.

Acabado

Aluminio Cepillado

Embalaje

30

0890101

Copete PVC

4 ml.

Blanco

30

0890320

Kit Accesorios

Gris

150

0890201

Kit Accesorios

Blanco

150



i Kit Accesorios compuesto por: 1 Rincón, 1 Esquina y 1 Juego de Tapas



Copete

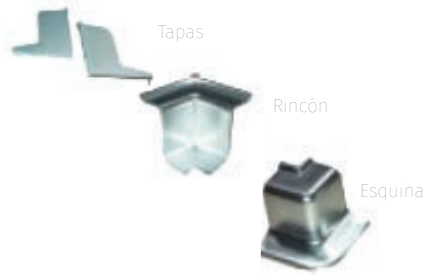
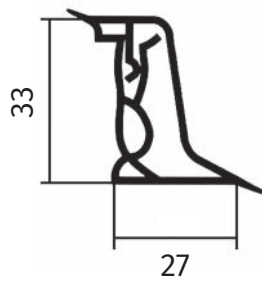

D2

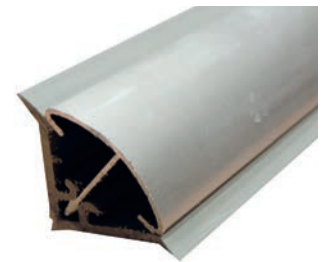
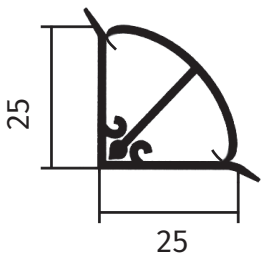

Código	Descripción	Longitud	Acabado	Embalaje
0840401	Copete Aluminio	4 ml	Blanco	20 
0840484	Copete Aluminio	4 ml	Bronce	20 
0800387	Copete Aluminio	4 ml	Plata	20 
0803401	Esquina	---	Blanco	25
0803384	Esquina	---	Bronce	25
0803187	Esquina	---	Plata	25
0802801	Rincón	---	Blanco	25
0802784	Rincón	---	Bronce	25
0802587	Rincón	---	Plata	25
0801601	Tapa Derecha	---	Blanco	100
0801584	Tapa Derecha	---	Bronce	100
0801387	Tapa Derecha	---	Plata	100
0802201	Tapa Izquierda	---	Blanco	100
0802184	Tapa Izquierda	---	Bronce	100
0801987	Tapa Izquierda	---	Plata	100

D3



Código	Descripción	Longitud	Acabado	Embalaje
0840601	Copete Aluminio	4 ml	Blanco	25 
0840792	Copete Aluminio	4 ml	Cromo Mate	25 
0800887	Copete Aluminio	4 ml	Plata	25 
0805201	Esquina	---	Blanco	100
0805492	Esquina	---	Cromo Mate	100
0804987	Esquina	---	Plata	100
0804601	Rincón	---	Blanco	100
0804892	Rincón	---	Cromo Mate	100
0804387	Rincón	---	Plata	100
0804001	Tapa	---	Blanco	100
0804292	Tapa	---	Cromo Mate	100
0803787	Tapa	---	Plata	100





Gola Abierta

Un clásico en la actualidad



Gola Abierta



Horizontal Encimera



Tapa Perfilada

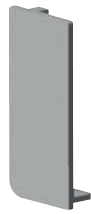

Tapa Cerrada

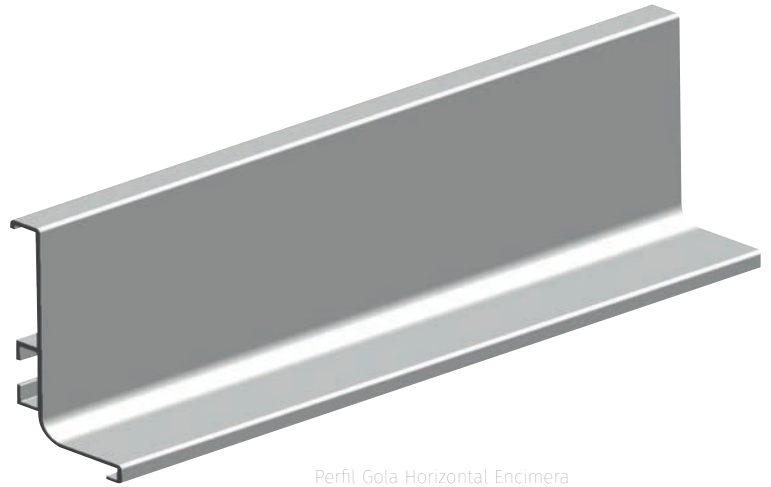

Perfil Gola Horizontal Encimera



Rincón



Esquina



Soporte Fijación Plástico



Soporte Fijación Metálico

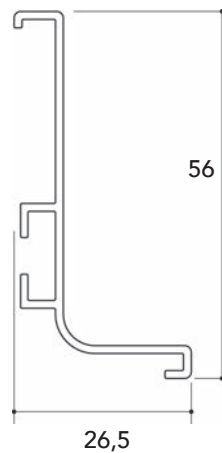

Sus beneficios

- » Acabado aluminio, inox y blanco.
- » Refuerzos exteriores que dan consistencia y minimizan posibles deficiencias en el mecanizado.
- » Tapa cerrada y tapa perfilada para aplicaciones específicas.
- » Accesorios para rincón y esquina en aluminio macizo.
- » Soporte fijación metálico para sujeción a costado o unión de ingletes.
- » Perfil provisto de film protector.

Código	Descripción	Longitud	Acabado	Embalaje
0842487	Perfil Gola Horizontal Encimera	4,10 ml.	Aluminio	16
0842490	Perfil Gola Horizontal Encimera	4,10 ml.	Ínox	16
0842401	Perfil Gola Horizontal Encimera	4,10 ml.	Blanco	16
0842687	Rincón Gola Horizontal Encimera	---	Aluminio	1
0842690	Rincón Gola Horizontal Encimera	---	Ínox	1
0842601	Rincón Gola Horizontal Encimera	---	Blanco	1
0842787	Esquina Gola Horizontal Encimera	---	Aluminio	1
0842790	Esquina Gola Horizontal Encimera	---	Ínox	1
0842701	Esquina Gola Horizontal Encimera	---	Blanco	1
0842887	Tapa Cerrada Base Dcha ABS	---	Aluminio	100
0842987	Tapa Cerrada Base Izda ABS	---	Aluminio	100
0842890	Tapa Cerrada Base Dcha ABS	---	Ínox	100
0842990	Tapa Cerrada Base Izda ABS	---	Ínox	100
0842801	Tapa Cerrada Base Dcha ABS	---	Blanco	100
0842901	Tapa Cerrada Base Izda ABS	---	Blanco	100
0520387	Tapa Perfilada Base Dcha ABS	---	Aluminio	100
0520487	Tapa Perfilada Base Izda ABS	---	Aluminio	100
0616887	Jgo. Soporte Fijación Plástico	---	Negro	200
0500168	Jgo. Soporte Fijación Metálico	---	Galvanizado	300

i Para cualquier otro acabado, consultar precio, cantidad mínima y plazo de entrega.



Gola Abierta



Horizontal Cajón

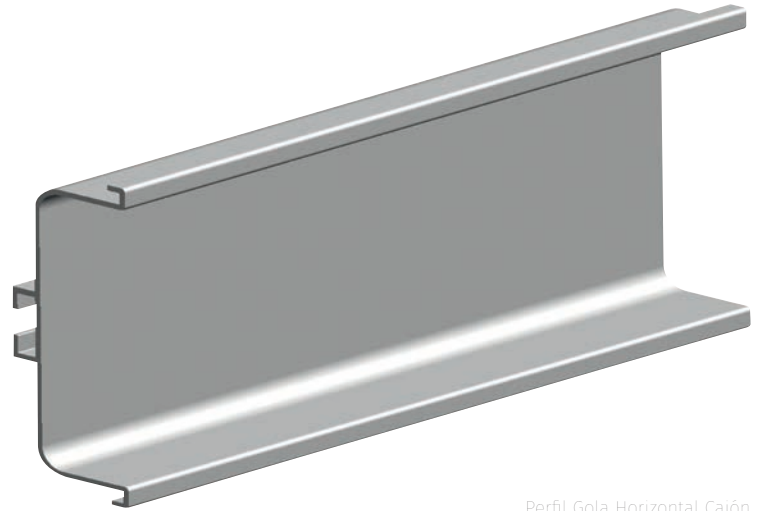
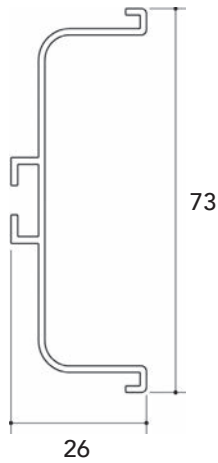

Perfil Gola Horizontal Cajón



Tapa Cerrada



Tapa Perfilada



Soporte Fijación Plástico



Soporte Fijación Metálico

Sus beneficios

- » Mayor dimensión que facilita la apertura de los cajones tanto en la parte superior como en la parte inferior.
- » Acabado aluminio, inox y blanco.
- » Refuerzos exteriores que dan consistencia y minimizan posibles deficiencias en el mecanizado.
- » Tapa cerrada y tapa perfilada para aplicaciones específicas.
- » Soporte de fijación metálico para sujeción a costado o unión de ingletes.
- » Perfil provisto de film protector.

Código	Descripción	Longitud	Acabado	Embalaje
0842287	Perfil Gola Horizontal Cajón	4,10 ml.	Aluminio	16
0842290	Perfil Gola Horizontal Cajón	4,10 ml.	Ínox	16
0842201	Perfil Gola Horizontal Cajón	4,10 ml.	Blanco	16
0616987	Tapa Cerrada Media ABS	---	Aluminio	100
0616990	Tapa Cerrada Media ABS	---	Ínox	100
0616901	Tapa Cerrada Media ABS	---	Blanco	100
0520287	Tapa Perfilada ABS	---	Aluminio	100
0616887	Jgo. Soporte Fijación Plástico	---	Negro	200
0500168	Jgo. Soporte Fijación Metálico	---	Galvanizado	300

i Para cualquier otro acabado, consultar precio, cantidad mínima y plazo de entrega.



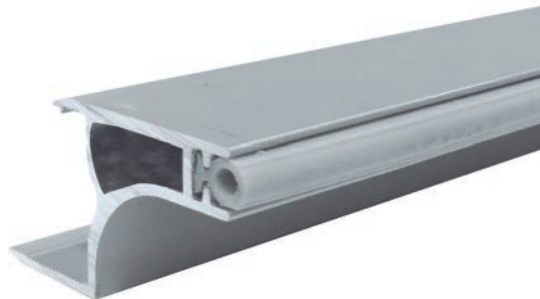
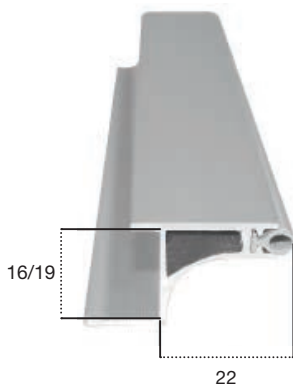

Horizontal Superior (Mueble Alto)



Perfil Gola Horizontal Superior (Mueble Alto)

Sus beneficios

- » Encaje estriado a la base del módulo que mejora la fijación y el ajuste al mismo.
- » Goma insertada que actúa como paracolpe y minimiza la sonoridad de la puerta al cerrar.

Código	Descripción	Longitud	Acabado	Embalaje
0520187	Perfil Gola Superior 16 mm	3 ml.	Aluminio	10 
0522787	Perfil Gola Superior 19 mm	3 ml.	Aluminio	18 



Perfil equipado con goma para reducir la sonoridad en el cierre de la puerta.





Gola Abierta



Vertical Lateral

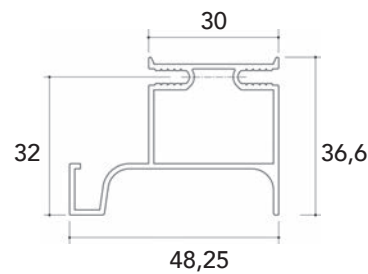
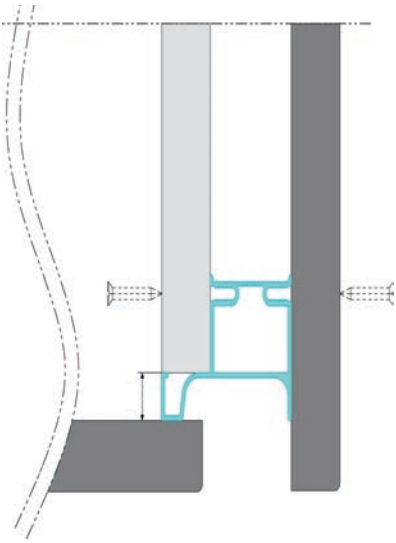

Sus beneficios

- » Nervio interior que ofrece la posibilidad de atornillar a costado.
- » Permite la apertura lateral de las puertas en módulos finales a pared o costado.
- » Perfil provisto de film protector.

Código

0616187

Descripción

Perfil Gola Lateral

Longitud

4,50 ml.

Acabado

Aluminio

Embalaje

15



Para cualquier otro acabado, consultar precio, cantidad mínima y plazo de entrega.

Vertical Media

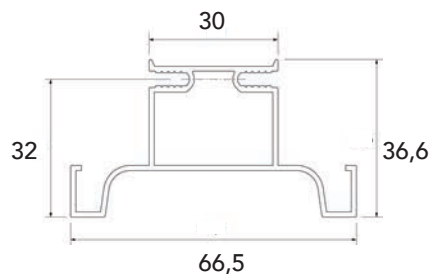
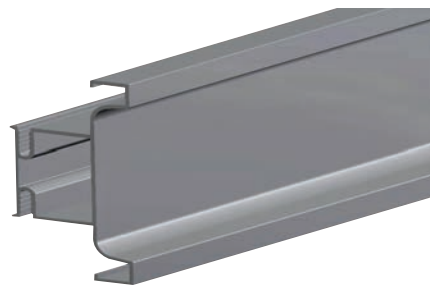
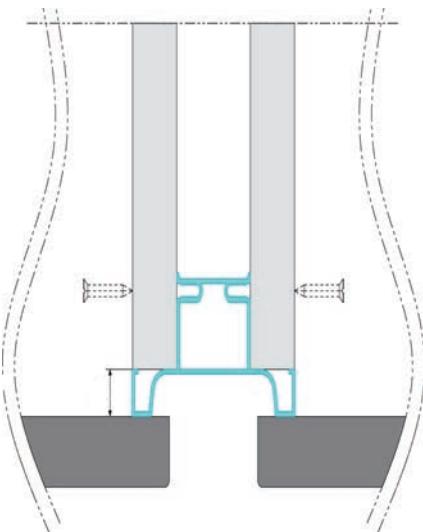

Sus beneficios

- » Nervio interior que ofrece la posibilidad de atornillar a costado.
- » Mayor dimensión que facilita la apertura de las dos puertas con comodidad.
- » Misma dimensión en ancho y fondo en espacio entre muebles que evita diferentes mecanizaciones.
- » Perfil provisto de film protector.

Código

0616087

Descripción

Perfil Gola Media

Longitud

4,50 ml.

Acabado

Aluminio

Embalaje

12



Para cualquier otro acabado, consultar precio, cantidad mínima y plazo de entrega.



Gola Cerrada

Una mirada al futuro

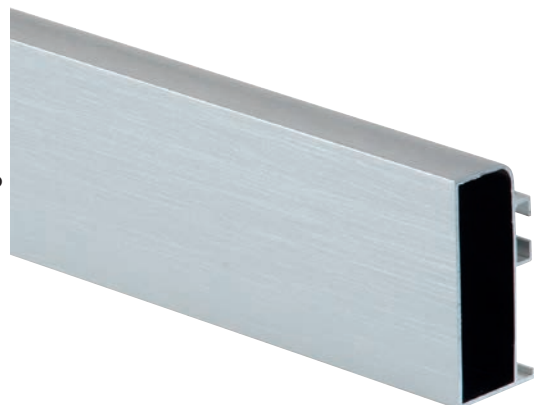
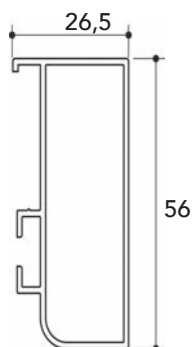

Tapa



Rincón



Esquina



Perfil Gola Cerrada Horizontal Encimera

Soporte Fijación Plástico

Soporte Fijación Metálico

Código	Descripción	Longitud	Acabado	Embalaje
0616287	Perfil Gola Base Cerrada	4,10 ml.	Aluminio	20
0616487	Rincón Gola Base Cerrada	---	Aluminio	1
0616587	Esquina Gola Base Cerrada	---	Aluminio	1
0842887	Tapa Gola Derecha ABS	---	Aluminio	100
0842987	Tapa Gola Izquierda ABS	---	Aluminio	100
0616887	Jgo. Soporte Fijación Plástico	---	Negro	200
0500168	Jgo. Soporte Fijación Metálico	---	Galvanizado	300



Gola Cerrada



Horizontal Cajón



Código	Descripción	Longitud	Acabado	Embalaje
0616387	Perfil Gola Media Cerrada	4,10 ml.	Aluminio	16
0616987	Tapa Gola ABS	---	Aluminio	100
0616887	Jgo. Soporte Fijación Plástico	---	Negro	200
0500168	Jgo. Soporte Fijación Metálico	---	Galvanizado	300

i Para cualquier otro acabado consultar precio, cantidad mínima de fabricación y plazo de entrega





Perfil Beta

Una alternativa acertada

Beta

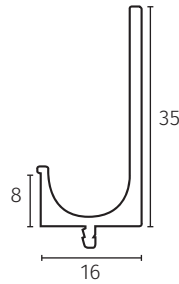

Código	Descripción	Ancho Perfil	Acabado	Embalaje
0511387	Perfil Beta Aluminio	147	Aluminio	40
0561087	Perfil Beta Aluminio	197	Aluminio	40
0511487	Perfil Beta Aluminio	247	Aluminio	40
0511587	Perfil Beta Aluminio	297	Aluminio	40
0511687	Perfil Beta Aluminio	347	Aluminio	40
0511787	Perfil Beta Aluminio	397	Aluminio	40
0511887	Perfil Beta Aluminio	447	Aluminio	40
0511987	Perfil Beta Aluminio	497	Aluminio	40
0512087	Perfil Beta Aluminio	597	Aluminio	40
0512187	Perfil Beta Aluminio	697	Aluminio	40
0512287	Perfil Beta Aluminio	797	Aluminio	40
0512387	Perfil Beta Aluminio	897	Aluminio	40
0512487	Perfil Beta Aluminio	997	Aluminio	40
0512587	Perfil Beta Aluminio	1197	Aluminio	40
0512687	Perfil Beta Aluminio	3000	Aluminio	40

Gamma

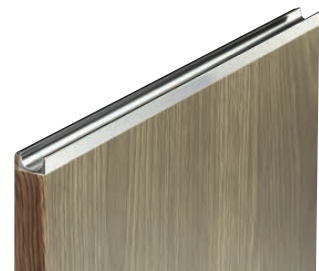
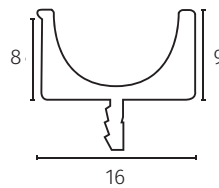
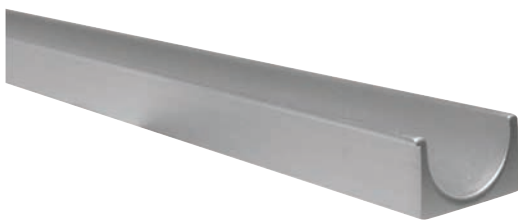

Código	Descripción	Longitud	Acabado	Embalaje
0514087	Perfil Gamma Aluminio	3 ml.	Aluminio	10

Perfil Uñero

Alpha

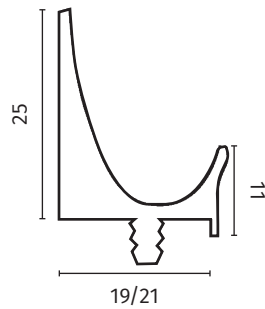

Código	Descripción	Ancho Perfil	Grosor Puerta	Acabado	Embalaje
0514187	Perfil Alpha Aluminio	147	19	Aluminio	10
0500787	Perfil Alpha Aluminio	247	19	Aluminio	10
0500887	Perfil Alpha Aluminio	297	19	Aluminio	10
0500987	Perfil Alpha Aluminio	347	19	Aluminio	10
0501087	Perfil Alpha Aluminio	397	19	Aluminio	10
0501187	Perfil Alpha Aluminio	447	19	Aluminio	10
0501287	Perfil Alpha Aluminio	497	19	Aluminio	10
0501387	Perfil Alpha Aluminio	597	19	Aluminio	10
0501487	Perfil Alpha Aluminio	697	19	Aluminio	10
0501587	Perfil Alpha Aluminio	797	19	Aluminio	10
0501687	Perfil Alpha Aluminio	897	19	Aluminio	10
0599187	Perfil Alpha Aluminio	997	19	Aluminio	5
0501787	Perfil Alpha Aluminio	1197	19	Aluminio	5
0514287	Perfil Alpha Aluminio	147	21	Aluminio	10
0510187	Perfil Alpha Aluminio	247	21	Aluminio	10
0510287	Perfil Alpha Aluminio	297	21	Aluminio	10
0510387	Perfil Alpha Aluminio	347	21	Aluminio	10
0510487	Perfil Alpha Aluminio	397	21	Aluminio	10
0510587	Perfil Alpha Aluminio	447	21	Aluminio	10
0510687	Perfil Alpha Aluminio	497	21	Aluminio	10
0510787	Perfil Alpha Aluminio	597	21	Aluminio	10
0510887	Perfil Alpha Aluminio	697	21	Aluminio	10
0510987	Perfil Alpha Aluminio	797	21	Aluminio	10
0511087	Perfil Alpha Aluminio	897	21	Aluminio	10
0511187	Perfil Alpha Aluminio	997	21	Aluminio	5
0511287	Perfil Alpha Aluminio	1197	21	Aluminio	5

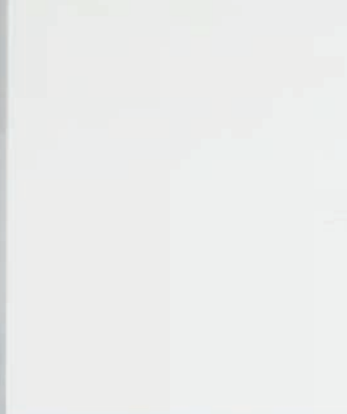
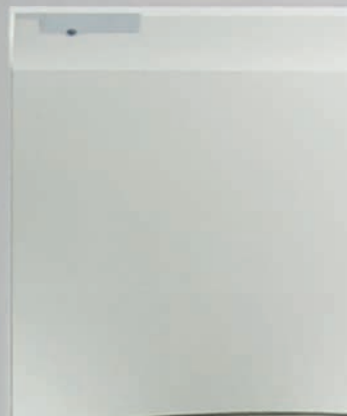



Vitrinas

Nuevos conceptos estéticos

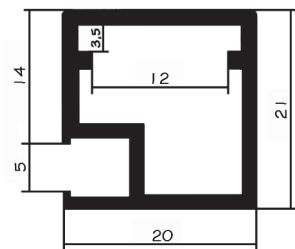

Código	Descripción	Longitud	Acabado	Embalaje
0501987	Perfil Vitrina Ada	3 ml.	Aluminio	10 Tiras
0500150	Junquillo Vitrina	3 ml.	Transparente	10 Tiras
0500198	Kit Escuadra/Tornillos	---	---	10

i La vitrina está mecanizada para emplear la bisagra cod. 0267095. (Ver pág. 113).

⚙ Espesor de cristal o metacrilato recomendado 4 mm.
Para calcular la medida del cristal o metacrilato, habrá que descontar a la medida justa de la vitrina 30 mm. tanto en ancho como en alto.

Lar

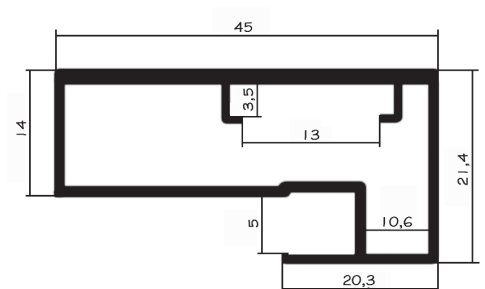

Código	Descripción	Longitud	Acabado	Embalaje
0502087	Perfil Vitrina Lar	3 ml.	Aluminio	10 Tiras 
0500150	Junquillo Vitrina	3 ml.	Transparente	10 Tiras 
0500198	Kit Escuadra/Tornillos	---	---	10

 Espesor de aluminio 2,5 mm.

 Espesor de cristal o metacrilato recomendado 4 mm.

Para calcular la medida del cristal o metacrilato, habrá que descontar a la medida justa de la vitrina 30 mm. tanto en ancho como en alto.

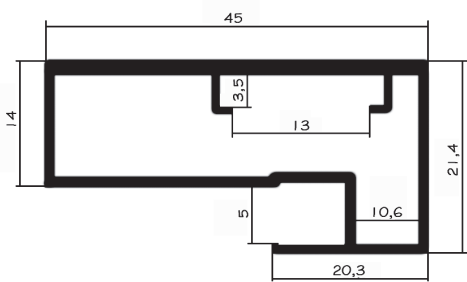

Código	Descripción	Longitud	Acabado	Embalaje
0502287	Perfil Vitrina Básica	3 ml.	Aluminio	10 Tiras
0500150	Junquillo Vitrina	3 ml.	Transparente	10 Tiras
0500198	Kit Escuadra/Tornillos	---	---	10

i Espesor de aluminio 1,8 mm.

⚙️ Espesor de cristal o metacrilato recomendado 4 mm.

Para calcular la medida del cristal o metacrilato, habrá que descontar a la medida justa de la vitrina 30 mm. tanto en ancho como en alto.

Básica Inox

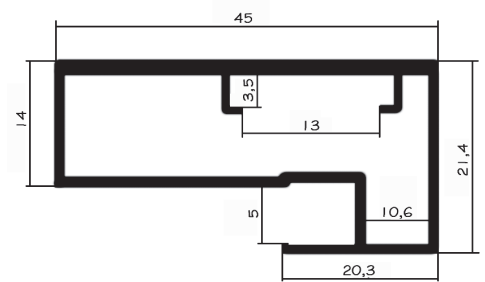

Código	Descripción	Longitud	Acabado	Embalaje
0500190	Perfil Vitrina Básica Inox	3 ml.	Aluminio	10 Tiras 
0500150	Junquillo Vitrina	3 ml.	Transparente	10 Tiras 
0500198	Kit Escuadra/Tornillos	---	---	10

i Espesor de aluminio 1,8 mm.

⚙️ Espesor de cristal o metacrilato recomendado 4 mm.

Para calcular la medida del cristal o metacrilato, habrá que descontar a la medida justa de la vitrina 30 mm. tanto en ancho como en alto.

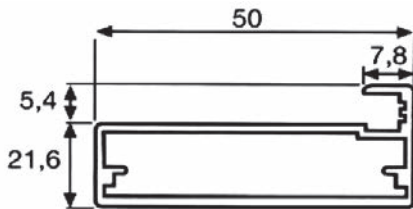

Código	Descripción	Longitud	Acabado	Embalaje
0502187	Perfil Vitrina Pel	3 ml.	Aluminio	10 Tiras
0500150	Junquillo Vitrina	3 ml.	Transparente	10 Tiras
0500198	Kit Escuadra/Tornillos	---	---	10

i



Espesor de cristal o metacrilato recomendado 4 mm.

Para calcular la medida del cristal o metacrilato, habrá que descontar a la medida justa de la vitrina 6 mm. tanto en ancho como en alto.

Mega

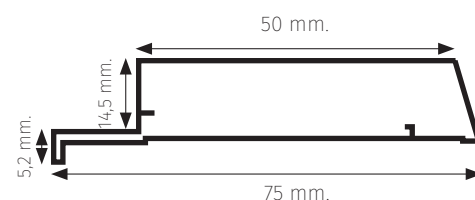
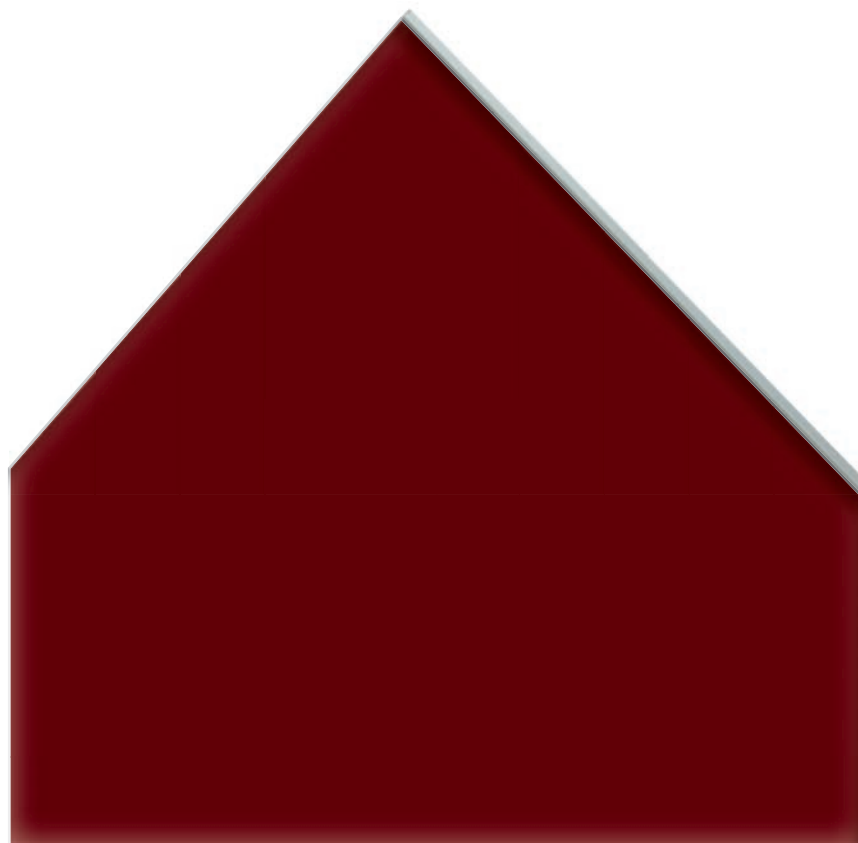

Código	Descripción	Longitud	Acabado	Embalaje
0599687	Perfil Vitrina Mega Gola	3 ml.	Aluminio	10 
0599787	Perfil Vitrina Mega Liso	3 ml.	Aluminio	10 
0500268	Kit Escuadra/Tornillos	---	---	10

i



Se recomienda emplear cristal templado con cantos pulidos en esta vitrina.



TIR

1,2,3 ¡Acción!

Ashen Ribbonwood, Avignon Walnut, Bark Microplank, Classic Wenge, Cottage Oak, Ebony Ribbonwood, Jarrah Legno, Millennium Oak, Mocca Firwood, Natural Ash, Natural Teak, Pecan Woodline, White Ash, Sombre Walnut, American Maple, Macchiato Walnut,

Chocolate

Diamond Black, Energy, Fog, Folkestone, Fossil, Just Blue, Maui, Lime, Seed, Storm, Surf, Vibrant Green, Carnaval, Just Gold, Amarena, Alpino, Arctic Blue, Baikal, Blanc Polaire, Blaze Red, Chrome Yellow, Clementine, Dusty Jade, Graphite, Hunter Green, Irish Cream, Oslo,

Negro

Malibu, Marine Blue, Monaco, Paprika, Patina, Peaceful Blue, Polar White, Sandstone, Soft White, Spectrum Blue, Storm, Tahiti, Tenere, Terracotta, Thistle, Tornado, Tropical Blue, Ultramarine, Vibrant Green, Wasabi, Hunter Green, Just Blue, Juicy Pink, Grotto, Denim,

Blanco

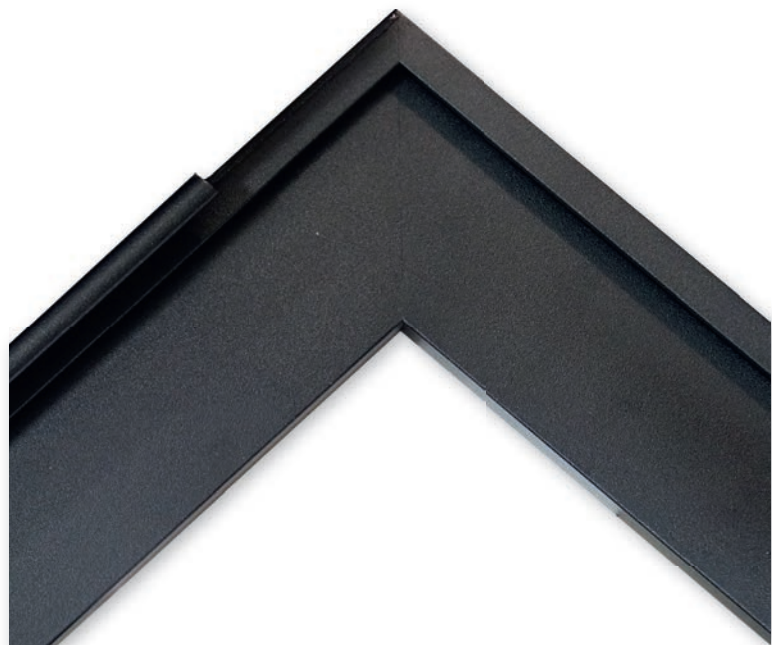

Tir

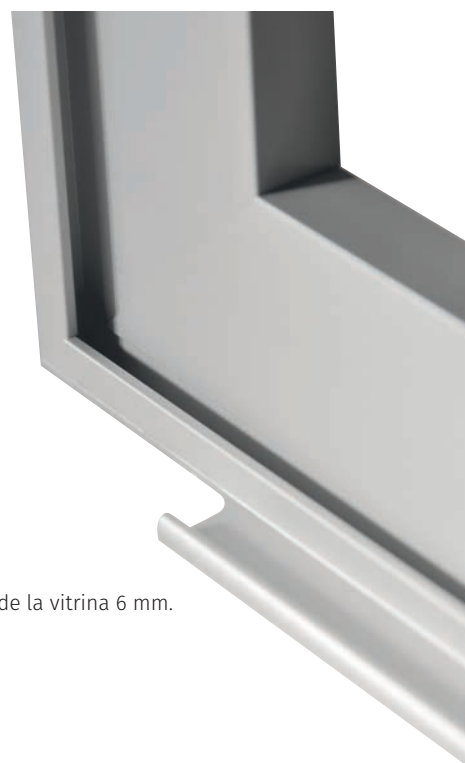
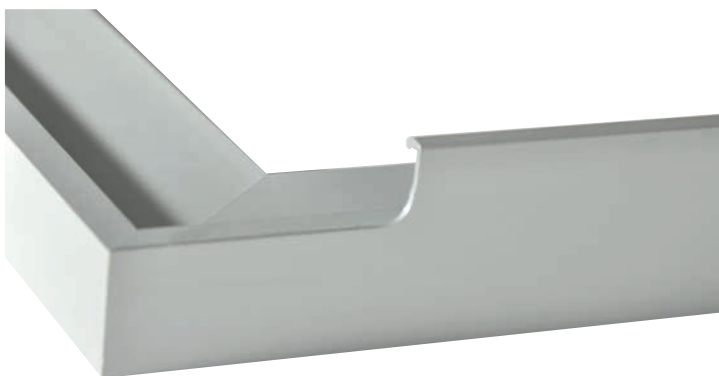
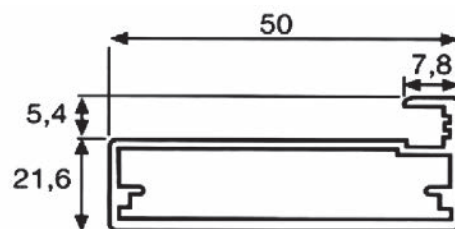

i



Esesor de cristal o metacrilato recomendado 4 mm.

Para calcular la medida del cristal o metacrilato, habrá que descontar a la medida justa de la vitrina 6 mm. tanto en ancho como en alto.

Ada

		Perfil ADA					
ANCHO ALTO		300	350	400	450	500	600
300							
350							
400							
450							
500							
600							
700							
800							
900							
1200							
1500							
2000							

Lar

		Perfil LAR					
ANCHO ALTO		300	350	400	450	500	600
300							
350							
400							
450							
500							
600							
700							
800							
900							
1200							
1500							
2000							

Básica

		Perfil BÁSICA					
ANCHO ALTO		300	350	400	450	500	600
300							
350							
400							
450							
500							
600							
700							
800							
900							
1200							
1500							
2000							

Básica Inox

		Perfil BÁSICA INOX					
ANCHO ALTO		300	350	400	450	500	600
300							
350							
400							
450							
500							
600							
700							
800							
900							
1200							
1500							
2000							

Pel

		Perfil PEL					
ANCHO ALTO		300	350	400	450	500	600
300							
350							
400							
450							
500							
600							
700							
800							
900							
1200							
1500							
2000							

Mega

		Perfil MEGA					
ANCHO ALTO		300	350	400	450	500	600
300							
350							
400							
450							
500							
600							
700							
800							
900							
1200							
1500							
2000							

Tir

		Perfil TIR					
ANCHO	ALTO	300	350	400	450	500	600
300							
350							
400							
450							
500							
600							
700							
800							
900							
1200							
1500							
2000							

Tir Chocolate

		Perfil TIR CHOCOLATE					
ANCHO	ALTO	300	350	400	450	500	600
300							
350							
400							
450							
500							
600							
700							
800							
900							
1200							
1500							
2000							

Tir Negro

		Perfil TIR NEGRO					
ANCHO	ALTO	300	350	400	450	500	600
300							
350							
400							
450							
500							
600							
700							
800							
900							
1200							
1500							
2000							

Tir Blanco

		Perfil TIR BLANCO					
ANCHO	ALTO	300	350	400	450	500	600
300							
350							
400							
450							
500							
600							
700							
800							
900							
1200							
1500							
2000							

i

Perfil Vitrina Alba



Perfil

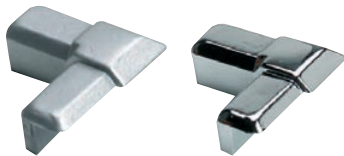

Ángulo

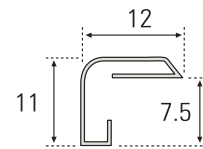

Código	Descripción	Longitud	Acabado	Embalaje
0810892	Perfil Vitrina	3 ml.	Cromo Mate	75
0810791	Perfil Vitrina	3 ml.	Cromo Brillo	75
0811492	Ángulo	---	Cromo Mate	100
0811391	Ángulo	---	Cromo Brillo	100

Perfil PVC Interior Vitrina

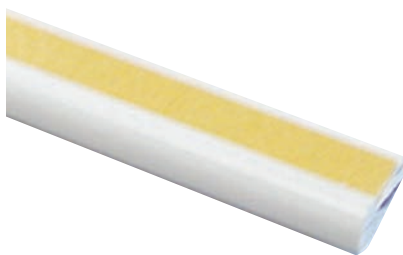

Perfil

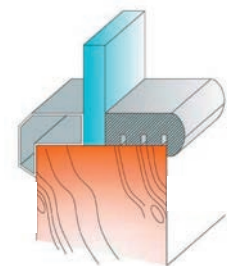
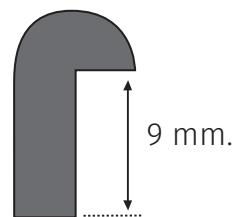

Código	Descripción	Longitud	Acabado	Embalaje
0815301	Perfil PVC interior con adhesivo	3 ml.	Blanco	75

Accesorios de Encimera

Código	Descripción	Grosor	Radio	Acabado	Embalaje
0822401	Cantonera	30 mm.	2r 6	Blanco	10 
0824894	Cantonera	30 mm.	2r 6	Cromo Mate	10 
0500194	Cantonera	30 mm.	1r 30	Cromo Mate	10 
0822387	Cantonera	30 mm.	2r 6	Plata	10 
0503187	Cantonera	30 mm.	1r 30	Plata	10 
0500494	Cantonera	38 mm.	2r 6	Cromo Mate	10 
0500487	Cantonera	38 mm.	2r 6	Plata	10 
0560187	Cantonera	30 mm.	2r 3	Cromo Mate	25 
0560487	Cantonera	30 mm.	Recta	Cromo Mate	25 
0560787	Cantonera	40 mm.	Recta	Cromo Mate	25 
0560191	Cantonera	30 mm.	2r 3	Plata	25 
0560491	Cantonera	30 mm.	Recta	Plata	25 
0560791	Cantonera	40 mm.	Recta	Plata	25 
0824001	Unión Angular	30 mm.	2r 6	Blanco	5 
0825694	Unión Angular	30 mm.	2r 6	Cromo Mate	5 
0500294	Unión Angular	30 mm.	1r 30	Cromo Mate	5 
0823987	Unión Angular	30 mm.	2r 6	Plata	5 
0503287	Unión Angular	30 mm.	1r 30	Plata	5 
0500594	Unión Angular	38 mm.	2r 6	Cromo Mate	5 
0503587	Unión Angular	38 mm.	2r 6	Plata	5 
0560287	Unión Angular	30 mm.	2r 3	Cromo Mate	25 
0560587	Unión Angular	30 mm.	Recta	Cromo Mate	25 
0560887	Unión Angular	40 mm.	Recta	Cromo Mate	25 
0560291	Unión Angular	30 mm.	2r 3	Plata	25 
0560591	Unión Angular	30 mm.	Recta	Plata	25 
0560891	Unión Angular	40 mm.	Recta	Plata	25 
0823201	Unión Recta	30 mm.	2r 6	Blanco	5 
0825294	Unión Recta	30 mm.	2r 6	Cromo Mate	5 
0500394	Unión Recta	30 mm.	1r 30	Cromo Mate	5 
0823187	Unión Recta	30 mm.	2r 6	Plata	5 
0503387	Unión Recta	30 mm.	1r 30	Plata	5 
0500694	Unión Recta	38 mm.	2r 6	Cromo Mate	5 
0503687	Unión Recta	38 mm.	2r 6	Plata	5 
0560387	Unión Recta	30 mm.	2r 3	Cromo Mate	25 
0560687	Unión Recta	30 mm.	Recta	Cromo Mate	25 
0560987	Unión Recta	40 mm.	Recta	Cromo Mate	25 
0560391	Unión Recta	30 mm.	2r 3	Plata	25 
0560691	Unión Recta	30 mm.	Recta	Plata	25 
0560991	Unión Recta	40 mm.	Recta	Plata	25 

1r 30 (30)

2r 6 (30)

2r 6 (38)

1r 30 (30)

2r 3 (30)

2r 3 (38)

1r 30 (30)

2r 6 (30)

2r 3 (38)

2r 3 (30)

Recta 30

Recta 40

2r 3 (30)

Recta 30

Recta 40

2r 3 (30)

Recta 30

Recta 40



BOSCH



Protector Costado

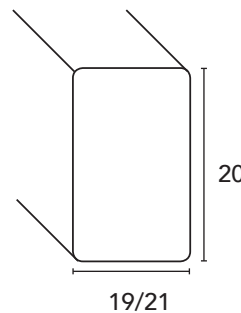

Sus beneficios

- » Fabricado en acero inox de 2 cms de altura que protege el costado del contacto directo con el suelo y la humedad.
- » Oculta posibles irregularidades del piso.
- » En stock para grosores de costado de 19 mm. y 21 mm.

Código	Descripción	Medida	Acabado	Embalaje
0500991	Protector Costado	600 x 20 x 19	Ínox	4
0501491	Protector Costado	600 x 20 x 21	Ínox	4

Protector Lateral Horno

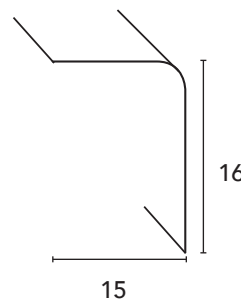

Sus beneficios

- » Protege el canto del módulo del calor producido por el horno.
- » Fabricado en acero inoxidable con mecanizados de fijación.

Código	Descripción	Medida	Acabado	Embalaje
0501091	Protector Lateral	600 x 15 x 16	Ínox	5

Protector Encimera

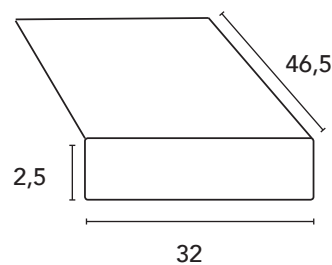

Sus beneficios

- » Accesorio multiusos, que preserva la superficie de trabajo de arañazos o del efecto de utensilios calientes.
- » Provisto en la parte inferior de topes antideslizantes.

Código	Descripción	Medida	Acabado	Embalaje
0501591	Protector Encimera	46,5 x 32 x 2,5	Ínox	10





Aireación

Múltiples Soluciones

Lateral de Campana



Código	Descripción	Fondo	Alto	Acabado	Embalaje
0409701	Jgo. Lateral de Campana	330	230	Blanco	50
0410089	Jgo. Lateral de Campana	330	230	Ínox	25
0410889	Jgo. Lateral de Campana	330	900	Ínox	5
0411089	Jgo. Lateral de Campana	330	700	Ínox	5

i Para cualquier otra medida consultar precio, cantidad mínima de fabricación y plazo de entrega



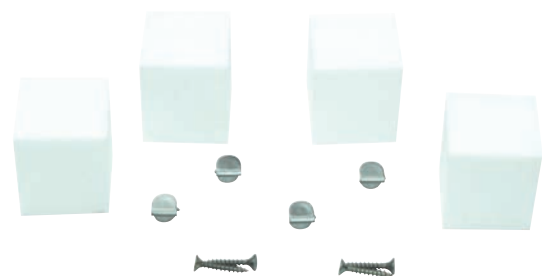



Marco Microondas Universal



Código	Descripción	Alto	Ancho	Acabado	Embalaje
0407601	Marco Microondas	400	600	Blanco	14
0407900	Marco Microondas	400	600	Ínox	14

Rejilla Aireación Aluminio



Código	Descripción	Alto	Ancho	Acabado	Embalaje
0433501	Rejilla Aireación	125	600	Blanco	20 
0433892	Rejilla Aireación	125	600	Cromo Mate	20 
0414389	Rejilla Aireación	125	600	Ínox	20 
0434001	Rejilla Aireación	125	900	Blanco	20 
0434392	Rejilla Aireación	125	900	Cromo Mate	20 
0414289	Rejilla Aireación	125	900	Ínox	20 

Rejilla Aireación Acero Inox



Código	Descripción	Alto	Ancho	Acabado	Embalaje
0433990	Rejilla Aireación	125	600	Acero Inox	25 
0434490	Rejilla Aireación	125	900	Acero Inox	25 

i Esta rejilla se suministra desmontada y embolsada individualmente.

Rejilla Aireación Tabica Horno



Código	Descripción	Alto	Ancho	Acabado	Embalaje
0413901	Rejilla Horno	85	600	Blanco	50
0414189	Rejilla Horno	85	600	Ínox	50

Rejilla Aireación Inducción

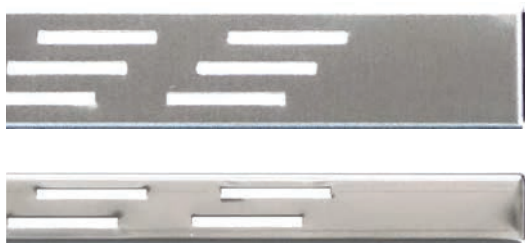

Código	Descripción	Alto	Ancho	Acabado	Embalaje
0410101	Rejilla Inducción	32	600	Blanco	20
0413789	Rejilla Inducción	32	600	Ínox	20
0413889	Rejilla Inducción	32	700	Ínox	20
0413989	Rejilla Inducción	32	800	Ínox	20
0410201	Rejilla Inducción	32	900	Blanco	20
0414089	Rejilla Inducción	32	900	Ínox	20
0414489	Rejilla Inducción	32	1000	Ínox	20
0414589	Rejilla Inducción	32	1200	Ínox	20
0570189	Rejilla Inducción	20	600	Ínox	20
0570289	Rejilla Inducción	20	800	Ínox	20
0570389	Rejilla Inducción	20	900	Ínox	20

Rejilla Aireación Zócalo

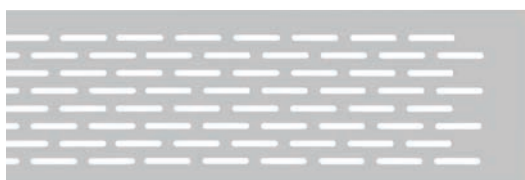

Código	Descripción	Alto	Ancho	Acabado	Embalaje
0413792	Rejilla Zócalo	70	445	Cromo Mate	10
0434501	Rejilla Zócalo	70	445	Blanco	10

BASE ABS KAUTÄT

Alta Gama, pequeños detalles

Solución de alta gama, para la perfecta protección de la base del mueble, previniendo la agresión del contacto de líquidos con la madera.

Acabado gris aluminio texturizado.

Fabricado en material de alta resistencia, su comportamiento es excelente ante cualquier producto de limpieza.

Óptima manipulación en ajustes y cortes.











Contorno del suelo equipado con un perfil antihumedad, que garantiza la estanqueidad del mueble.

Posibilidad de personalización en serigrafía unicolor negra.

Base ABS Perfil Antihumedad



i Personalizable pintura unicolor negro. Consultar precio, cantidad mínima de fabricación y plazo de entrega

Código	Descripción	Ancho Módulo	Fondo	Acabado	Embalaje
0502320	Bandeja protec. ABS mueble fregadero con perfil antihumedad	400	580	Gris	10 
0502420	Bandeja protec. ABS mueble fregadero con perfil antihumedad	450	580	Gris	10 
0502520	Bandeja protec. ABS mueble fregadero con perfil antihumedad	500	580	Gris	10 
0502620	Bandeja protec. ABS mueble fregadero con perfil antihumedad	600	580	Gris	15 
0502720	Bandeja protec. ABS mueble fregadero con perfil antihumedad	700	580	Gris	15 
0502820	Bandeja protec. ABS mueble fregadero con perfil antihumedad	800	580	Gris	15 
0502920	Bandeja protec. ABS mueble fregadero con perfil antihumedad	900	580	Gris	15 
0503020	Bandeja protec. ABS mueble fregadero con perfil antihumedad	1000	580	Gris	15 
0503420	Bandeja protec. ABS mueble fregadero con perfil antihumedad	1100	580	Gris	15 
0503120	Bandeja protec. ABS mueble fregadero con perfil antihumedad	1200	580	Gris	10 

i Este artículo está fabricado para módulos de grueso de costado 16 mm. Para fondos y anchos especiales consultar precio, cantidad mínima y plazo de entrega.

Base Rombotino Perfil Antihumedad

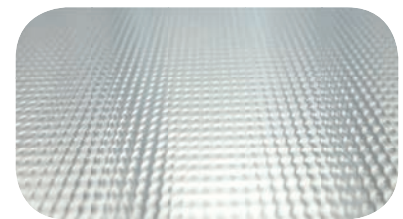

Detalle del rombotino

Código	Descripción	Ancho Módulo	Fondo	Acabado	Embalaje
0406387	Bandeja protectora mueble fregadero con perfil antihumedad	400	580	Aluminio	10 
0406487	Bandeja protectora mueble fregadero con perfil antihumedad	450	580	Aluminio	10 
0406587	Bandeja protectora mueble fregadero con perfil antihumedad	500	580	Aluminio	10 
0406687	Bandeja protectora mueble fregadero con perfil antihumedad	600	580	Aluminio	10 
0406787	Bandeja protectora mueble fregadero con perfil antihumedad	700	580	Aluminio	10 
0406887	Bandeja protectora mueble fregadero con perfil antihumedad	800	580	Aluminio	10 
0406987	Bandeja protectora mueble fregadero con perfil antihumedad	900	580	Aluminio	10 
0407087	Bandeja protectora mueble fregadero con perfil antihumedad	1000	580	Aluminio	10 
0407187	Bandeja protectora mueble fregadero con perfil antihumedad	1100	580	Aluminio	10 
0407287	Bandeja protectora mueble fregadero con perfil antihumedad	1200	580	Aluminio	10 
0407387	Bandeja protectora mueble fregadero con perfil antihumedad	1350	580	Aluminio	10 

i Este artículo está fabricado para módulos de grueso de costado 16 mm. Para fondos y anchos especiales consultar precio, cantidad mínima y plazo de entrega.

Supra Delantero

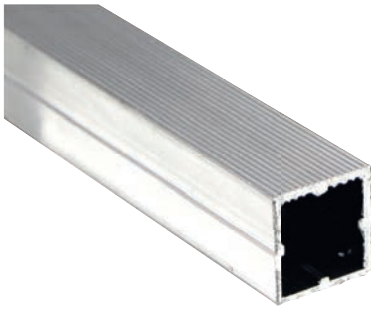

Soporte con Taco



Soporte con Taco + Fijación Encimera

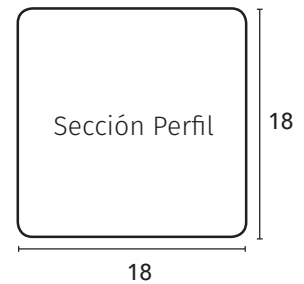

Sección Perfil

18

Código	Descripción	Medida	Mueble	Acabado	Embalaje
0520987	Perfil Refuerzo Delantero	418	450	Aluminio/Gris	25
0521087	Perfil Refuerzo Delantero	468	500	Aluminio/Gris	25
0521187	Perfil Refuerzo Delantero	568	600	Aluminio/Gris	25
0521287	Perfil Refuerzo Delantero	668	700	Aluminio/Gris	25
0521387	Perfil Refuerzo Delantero	768	800	Aluminio/Gris	25
0521487	Perfil Refuerzo Delantero	868	900	Aluminio/Gris	25
0521587	Perfil Refuerzo Delantero	968	1000	Aluminio/Gris	25
0521687	Perfil Refuerzo Delantero	1168	1200	Aluminio/Gris	25
0521787	Perfil Refuerzo Delantero	3000	---	Aluminio	18
0501020	Soporte con Taco	---	---	Gris	200
0501120	Soporte con Taco + Fijación Encimera	---	---	Gris	200

i El perfil montado, se sirve con el soporte con taco 0501020. Para otra medidas de perfil consultar precio,cantidad y plazo de entrega.

Supra Trasero



Soporte Izquierda



Soporte Derecha

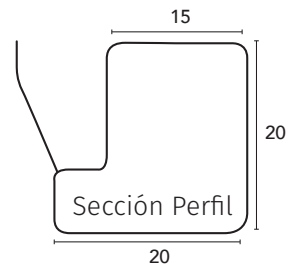

Sección Perfil

20

Código	Descripción	Medida	Mueble	Acabado	Embalaje
0521887	Perfil Refuerzo Trasero	418	450	Aluminio/Gris	25
0521987	Perfil Refuerzo Trasero	468	500	Aluminio/Gris	25
0522087	Perfil Refuerzo Trasero	568	600	Aluminio/Gris	25
0522187	Perfil Refuerzo Trasero	668	700	Aluminio/Gris	25
0522287	Perfil Refuerzo Trasero	768	800	Aluminio/Gris	25
0522387	Perfil Refuerzo Trasero	868	900	Aluminio/Gris	25
0522487	Perfil Refuerzo Trasero	968	1000	Aluminio/Gris	25
0522587	Perfil Refuerzo Trasero	1168	1200	Aluminio/Gris	25
0522687	Perfil Refuerzo Trasero	3000	---	Aluminio	18
0501220	Soporte Derecha	---	---	Gris	200
0501320	Soporte Izquierda	---	---	Gris	200

i Para trasera de 4 a 8 mm. Para otra medidas de perfil consultar precio,cantidad y plazo de entrega.

Perfil Refuerzo KAUTÄT



Deluxe

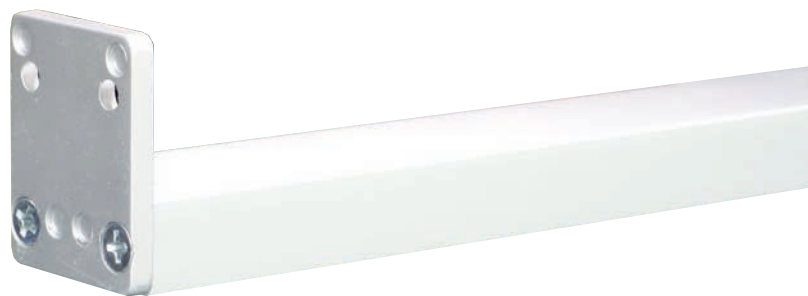
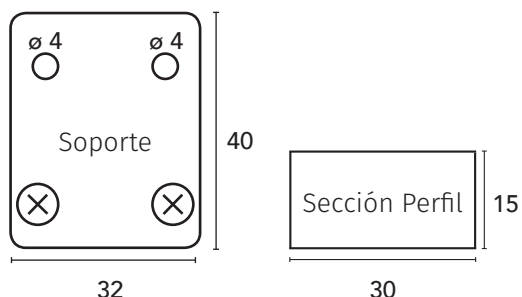

Código	Descripción	Medida	Acabado	Embalaje
0896787	Perfil Refuerzo Deluxe	3000	Aluminio	10
0891587	Soporte Refuerzo 40 x 32	---	Zamak	100

i En los soportes no van incluidos los tornillos de fijación.



Concept

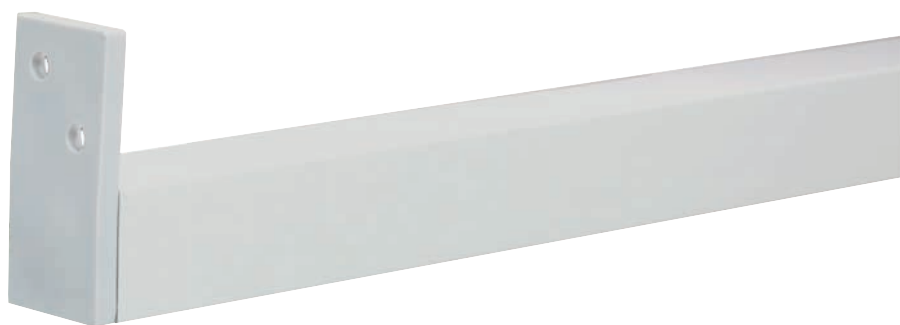
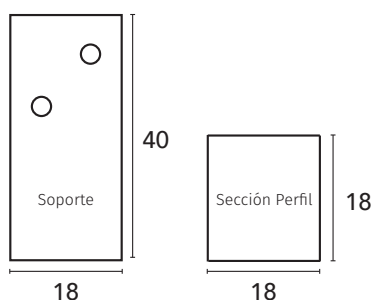

Código	Descripción	Medida	Mueble	Acabado	Embalaje
0838787	Perfil Refuerzo Concept	418	450	Aluminio / Gris	10
0838887	Perfil Refuerzo Concept	468	500	Aluminio / Gris	10
0838987	Perfil Refuerzo Concept	568	600	Aluminio / Gris	10
0839087	Perfil Refuerzo Concept	668	700	Aluminio / Gris	10
0839187	Perfil Refuerzo Concept	768	800	Aluminio / Gris	10
0839287	Perfil Refuerzo Concept	868	900	Aluminio / Gris	10
0839387	Perfil Refuerzo Concept	968	1000	Aluminio / Gris	10
0839487	Perfil Refuerzo Concept	1168	1200	Aluminio / Gris	10
0890387	Perfil Refuerzo Concept	3000	---	Aluminio	30
0890487	Soporte Refuerzo Atornillar	---	---	Gris	100

i Para otra medidas de perfil consultar precio,cantidad y plazo de entrega.



Sus beneficios

- » Solución de alta gama para unir puertas en módulos de columna o semicolumna donde por estética del amueblamiento, se opta por poner 2 puertas.
- » Nervio central que tapa el posible hueco de luces de dicha unión.
- » Perfil cortado y mecanizado láser.

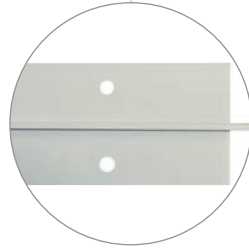

Código	Descripción	Alto	Ancho	Acabado	Embalaje
0561187	Perfil Unión Puertas	40	277	Aluminio	1
0561287	Perfil Unión Puertas	40	427	Aluminio	1
0561387	Perfil Unión Puertas	40	577	Aluminio	1

